



PL - INSTRUKCJA U YTKOWANIA (2-11)
SOKOWIRÓWKA TYP 496

ZELMER S.A.

35-016 Rzeszów, ul. Hoffmanowej 19
POLSKA
www.zelmer.pl

CZ - NÁVOD K POUŽITÍ (12-21)

ODŠ AVOVA TYP 496

ZELMER CZECH s.r.o.

Horní T rlicko 770, 735 42 T rlicko
Tel.: 596 423 710 Fax: 596 423 713
Mobilní telefon: 602 583 958
e-mail: zelmer@zelmer.cz

SK - NÁVOD NA POUŽITIE (22-31)

ODŠ AVOVA TYP 496

ZELMER SLOVAKIA s.r.o.

Bidovce 316, 044 45 Bidovce
Tel.: 055/720 40 20 Fax: 055/720 40 40
e-mail: zelmer@zelmer.sk
www.zelmer.sk

H - HASZNÁLATI UTASÍTÁS (32-41)

LÉCENTRIFUGA TÍPUS 496

ASPICO KFT

H-9027 Gy r, Puskás T. u. 4
Tel. +36 96 511 291
Fax. +36 96 511 293

RU - (42-51)

496

" " , 30/34

7708619872; 770801001
044525716; 7710353606

UA - (52-61)

496

Zelmer Ukraine

" »
18/20, 04080

: +380 44 501 5626
: +380 44 501 5636

www.zelmer.ua

RO - INSTRUC IUNI DE UTILIZARE (62-71)

STORC TOR DE FRUCTE TIP 496

Zelmer Romania

Popa Savu Street No. 77, Office No. 1, First Floor
District 1 Bucharest, ROMANIA
Phone No/Fax : +40.21.22.22.173
Mobil Phone: +40.726.110.701

BG - (72-81)

496

" : - 90
1700

: 02/9601201, : 02/9601207

EN - USER'S MANUAL (82-91)

JUICE EXTRACTOR TYPE 496

!

C

.....	42
.....	43
.....	44
.....	44
.....	45
..... (,)	45
..... ee	46
..... ()	47
.....	47
.....	48
.....	48
.....	50
.....	51
.....	51

496

(,) , 2

TURBO

1,5 ÷ 2

TURBO

10

15

1

230V.

()).

()).

60°C.



I		I	
A	II	M	II
	I		I
	I		I
	I		I
	I	O	I
	I		I
Ka	II		I
	I		II
Ma	I		I

TURBO

15
30
10
79 dB/A

: 496 II

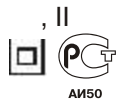

(LVD) - 2006/95/EC
(EMC) - 2004/108/EC

CE.

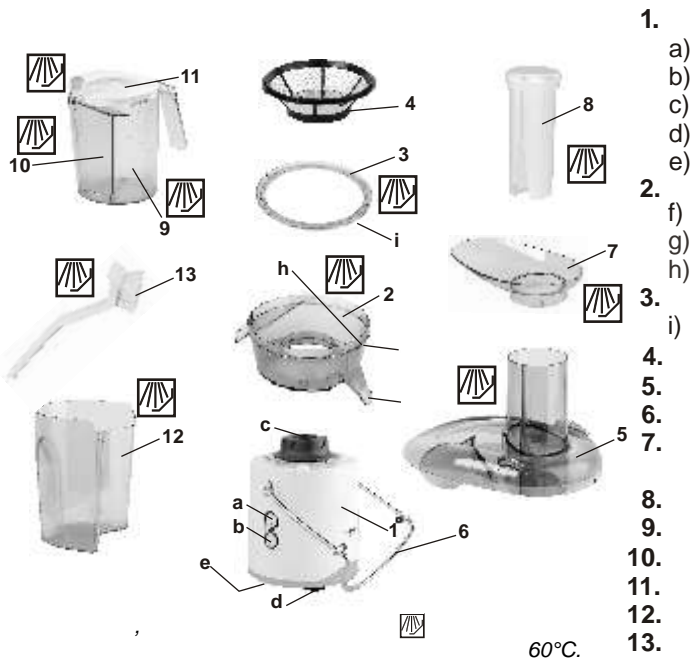

- 1.
- a)
- b)
- c)
- d)
- e)
- 2.
- f)
- g)
- h)
- 3.
- i)
- 4.
- 5.
- 6.
- 7.
- 8.
- 9.
- 10.
- 11.
- 12.
- 13.

I-0-II
TURBO

60°C.



(,)

-
-
- (6)
- (8), (5)
- (2)
- (4)
- (2)
- (1)
- (f)
- (1)
- (1)
- (2)
- (1)
- (2)

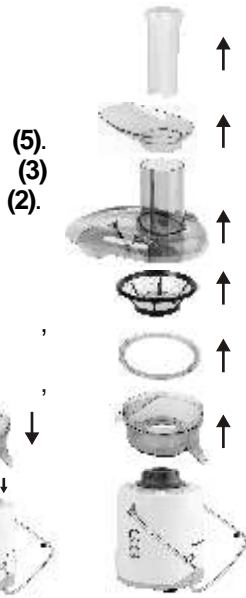

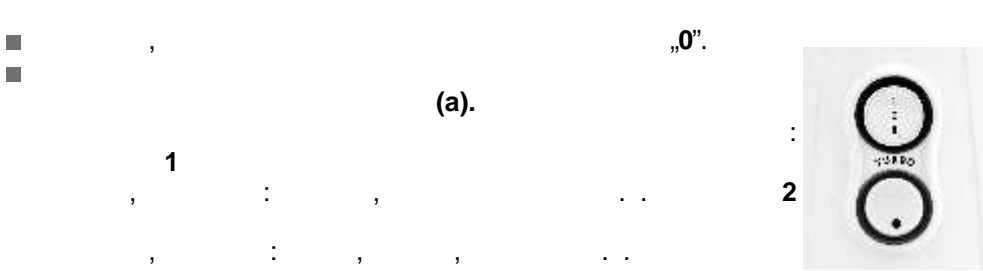
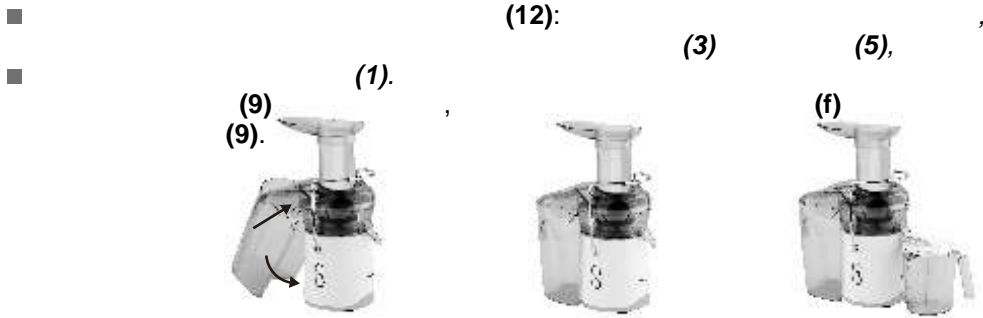
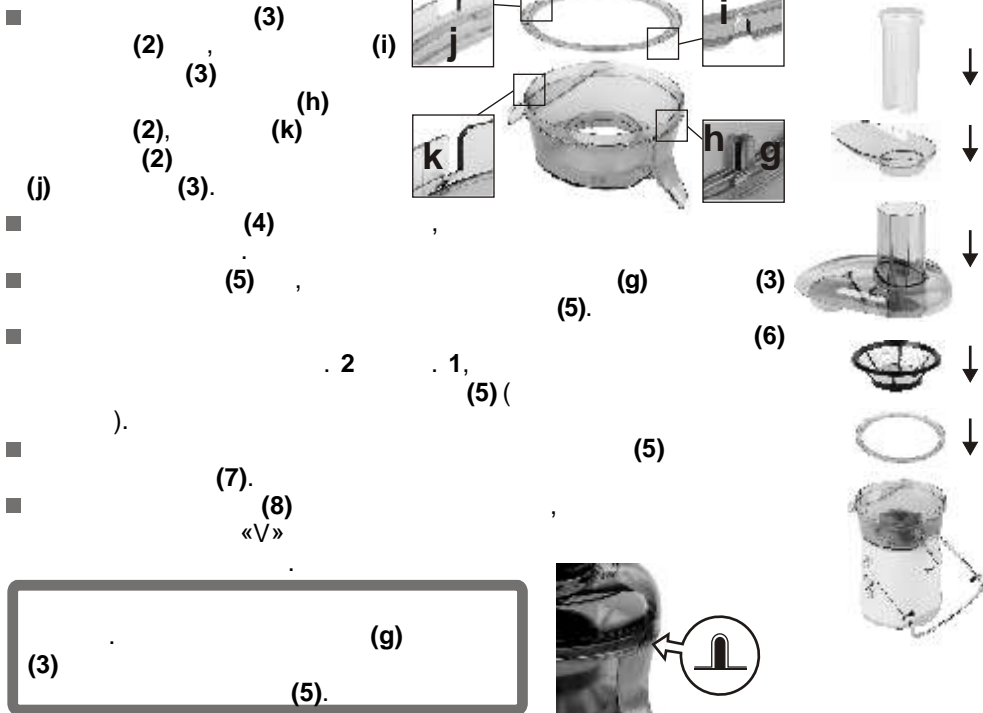

[Empty box]

(
TURBO (b).
.2 . *TURBO*
! *TURBO* 10

■
■ (7).
■ (9) (10),
■
■ () (a) „0”
■
■ („ ”).
■ O

[Empty box]

■
■
■ (

[Empty box]

■
■
■ (13). (4). .60°C.
! 



: 3 4

/

TURBO.



C.

A C.



6		4		2
2		1/2		6
1/2		1		
	”	”	”	”
3		2		
1/2		1		1
1		1/4		1
1/4		6		2
				4

K

(PE)



!!!