



MOTOROLA

User Manual

SlimLite

GSM

Options Menu

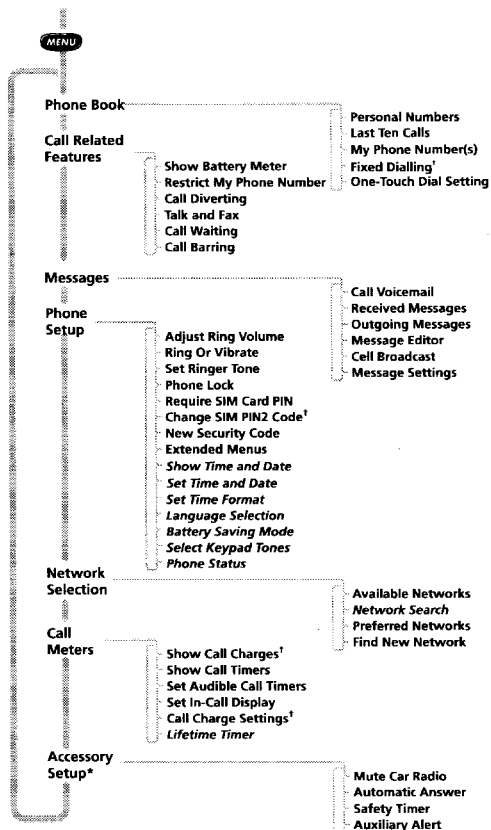

Quick Access Menu ‡

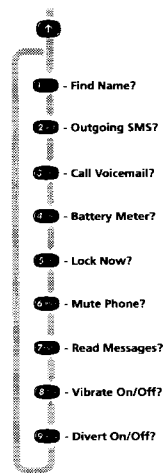

Menu Navigation











Items shown in *italics* are available only when **Extended Menus** are switched on.

† Availability depends on the type of SIM card.

* The **Accessory Setup** option is available only when a car kit is fitted.

‡ The features and the positions of the features in the Quick Access menu can be changed.

Special Keys

-  Press to turn phone on and off.
-  Press to accept call, setting, option,...
-  Press to access the Quick Access features.
-  Press to access the Options or phone book menus.
-  Press to reject call, setting, option,...
-  Press to scroll backwards and forwards.
-  Press to add a phone book entry.
-  Press to retrieve a phone book entry.

Making a Call

Enter **Phone No.** .





Receiving a Call

Press .



Ending a Call

Press .

Making an Emergency Call

Enter    . The call will be directed to a central emergency operator.



Redialling the Last Number Called

- 1 Press  to display the last number dialled.
- 2 Press  to call the number.







Locking the Keypad

Press  and  simultaneously to lock the keypad.



One-Touch Dialling

Press and hold the appropriate digit key  to  for numbers in the first nine memory locations.



Storing Numbers in the Phone Book

- 1 Press  to access the Phone Book.
- 2 Press  to select phone memory, or   to select SIM card memory.
- 3 Enter **Phone No.** , then **Name** , then **Location** .

Dialling Phone Book Numbers

Press  **Location** .

Quick Access Features

Press  followed by the appropriate key, or press , scroll to the feature and press  to select.



Introduction

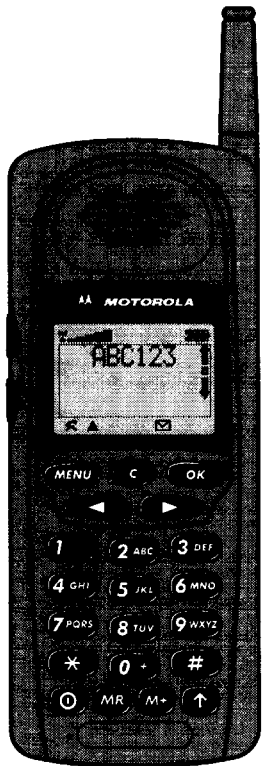

Congratulations on your purchase of a cellular telephone from *Motorola*, the world leader in cellular technology.

All *Motorola* cellular telephones are manufactured to exacting specifications and world-class quality standards, and are designed to withstand the harshest environmental conditions. Our commitment to Total Customer Satisfaction and over sixty five years of experience in personal communications mean you can depend upon the quality of this *Motorola* product.

This cellular telephone incorporates **Personality™**. Unique to *Motorola*, **Personality™** removes the complexity of cellular communications by guiding you through the features and presenting you with simple choices every step of the way. **Personality™** also allows you to personalise the way you use your phone - for example, different ringer tones, a phone book and network selection preferences - all presented with clarity and simplicity. In this manual, each of the **Personality™** features is identified with an O symbol to indicate that it is customisable to meet your requirements.

This cellular telephone has been designed for use with the worldwide GSM (Global System for Mobile communications) network. By using digital communications methods, your phone provides a number of advantages over traditional cellular systems:

- Superior speech quality is attained without the usual background noises and interference.
- Your conversation may be encrypted for security. Conversations cannot be eavesdropped using scanning equipment when the signal is encrypted.
- You are not restricted to use within one country.

Your subscriber number is not contained within the phone as with other systems. Instead, a 'Smart Card' known as a SIM (Subscriber Identity Module) is supplied by your Cellular Service Provider. All call billing is made to the subscriber number on the card whether it is used in this or any other GSM unit.

Getting Started

In order to get started straight away with your new GSM SlimLite, follow these simple steps:

Charge the Battery

I Before you use your phone, please see the 'Your Battery' section for important information on battery charging.

- 1 Remove the battery from its holder and clip it into your phone.

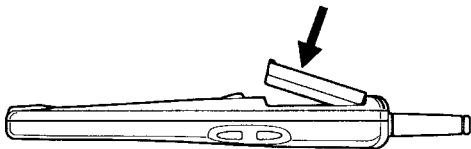

- 2 Connect the travel charger to the phone and plug it into a standard mains socket.

Powering On

- 1 Insert the SIM card into the slot at the base of the battery compartment, being careful to match the orientation of the card to the drawing on the label.
- 2 Fully extend the antenna.
- 3 Press **⏻** to switch on.
- 4 If prompted, enter your PIN code and press **OK**.

Once a GSM network is located by your phone, it connects and the network name appears on the display.

Making a Call

- 1 Enter the number you want to call.
I Even if you call a local number, you must also enter the full area (but not country) code.
- 2 Press **OK**. Your call is placed!

IMPORTANT! Ending a Call

When you have finished your conversation, you *must* end the call, even if the other person terminates the call. To end the call, press **OK** or **C**.

I If you do not end the call, you will remain connected and you will be charged for the duration of the connection.

Exploring

Now you can leave your phone on while charging the battery, making and receiving calls, and exploring features of your phone at your leisure.

Safety	
Important information for the efficient and safe operation of your phone	5
About Your Phone, Battery and SIM Card	
Introduces your phone, explains how to charge and maintain batteries and explains about your SIM Card	9
Making and Receiving Phone Calls	
Explains how to call a number, how to redial and how to accept a call.....	17
Menu Navigation	
Explains how to access and use the phone's menus	23
Using The Options Menu	
Provides an explanation of the Options Menu and how to use it.....	27
Using the Quick Access Menu	
Provides an explanation of the Quick Access Menu and how to use it.....	59
Accessories	
Details the accessories available for use with your phone.....	63
What To Do If...	
Helps you to solve any problems that may occur.....	65
Index	
A comprehensive index	67



Understanding this Manual

Many of your phone options are accessed by a simple menu system. A full description of the menus and how to move around them is covered in the later section **Menu Navigation**. When the manual describes the use of each menu item, it will be assumed that you are familiar with the menu system.

Key Presses

Key presses are represented in this manual using symbols so that you may locate and use the required sequence quickly. A sequence of key presses may be shown as follows:



This means that you should press **MENU** followed by **OK** and then **C**, in sequence, not simultaneously.

Entering Information

When you are requested to enter information, such as the number of the phone you wish to call, this is represented in **bold** type. For example:

Phone No. - enter the required telephone number.

PIN - enter your Personal Identification Number.

Unlock Code - enter your unlock code.

Location - enter the Phone Book location number.





Prompts and Messages

Your phone responds to key presses by displaying either easy to understand prompts that guide you to the next action, or simple messages confirming that your action is complete. Prompts and messages are represented in this manual in LCD style, for example:

Enter PIN or Completed.

Other Symbols

You will find the following symbols used throughout this manual:

-  A Note contains additional information which is relevant to the feature/item.
-  A Caution contains important additional information which is relevant to the efficient and/or safe usage of your phone.
-  This symbol indicates that the feature is a **Personality™** feature that can be customised to meet your requirements.
-  This symbol indicates a short key sequence for the feature.

IMPORTANT

For the efficient and safe operation of your GSM Cellular Telephone, Read this information before use.

Your GSM cellular telephone is one of the most exciting and innovative electronic products ever developed. With it you can stay in contact with your office, your home, emergency services, and others, wherever service is provided.

General

Your cellular telephone utilizes the GSM standard for cellular technology. GSM is a newer radio frequency ("RF") technology than the current FM technology that has been used for radio communications for decades. The GSM standard has been established for use in the European Community and elsewhere.

Your cellular telephone is actually a low power radio transmitter and receiver. It sends out and receives radio frequency energy. When you use your cellular telephone, the cellular system handling your call controls both the radio frequency and the power level of your cellular telephone.

Exposure To RF Energy

There has been some public concern about possible health effects of using cellular telephones. Although research on health effects from RF energy has focused for many years on the current RF technology, scientists have begun research regarding newer radio technologies such as GSM. After existing research had been reviewed, and after compliance to all applicable safety standards had been tested, it has been concluded that the product is fit for use.

If you are concerned about exposure to RF energy there are things you can do to minimize exposure. Obviously, limiting the duration of your calls will reduce your exposure to RF energy. In addition, you can reduce RF exposure by operating your cellular telephone efficiently, according to the following guidelines.

Efficient Phone Operation

For your phone to operate at the lowest power level consistent with satisfactory quality, observe the following guidelines.

If your phone has an extendable antenna, extend it fully. Some models allow you to place a call with the antenna retracted. However, your phone operates more efficiently with the antenna fully extended.

Hold the phone as you would any other telephone. While speaking directly into the mouthpiece, position the antenna up and over your shoulder.

Do not hold the antenna when the phone is "IN USE". Holding the antenna affects call quality and may cause the phone to operate at a higher power level than needed.

Antenna Care and Replacement

Do not use the phone with a damaged antenna. If a damaged antenna comes into contact with the skin, a minor burn may result. Replace a damaged antenna immediately. Consult your manual to see if you may change the antenna yourself. If so, use only a manufacturer-approved antenna. Otherwise, have your antenna repaired by a qualified technician.

Use only the supplied or approved antenna. Unauthorised antennas, modifications or attachments could damage the phone and may contravene local RF emission regulations or invalidate type approval.

Driving

Check the laws and regulations on the use of cellular telephones in the areas where you drive. Always obey them. Also, when using your phone while driving, please:

- give full attention to driving,
- use hands-free operation, if available, and
- pull off the road and park before making or answering a call if driving conditions so require.





Electronic Devices

Most electronic equipment, for example in hospitals and motor vehicles, is shielded from RF energy. However, RF energy may affect some malfunctioning or improperly shielded electronic equipment.

Vehicle Electronic Equipment

Check with your vehicle manufacturer's representative to determine if any on board electronic equipment is adequately shielded from RF energy.

Medical Electronic Equipment

Consult the manufacturer of any personal medical devices (such as pacemakers, hearing aids, etc.) to determine if they are adequately shielded from external RF energy.

Turn your phone **OFF** in health care facilities when any regulations posted in the area instruct you to do so. Hospitals or health care facilities may be using RF monitoring equipment.

Aircraft

Turn your phone **OFF** before boarding any aircraft.

- Use it on the ground only with crew permission.
- Do not use in the air.

To prevent possible interference with aircraft systems, Federal Aviation Administration (FAA) regulations require you to have permission from a crew member to use your phone while the plane is on the ground. To prevent interference with cellular systems, local RF regulations prohibit using your phone whilst airborne.

Children

Do not allow children to play with your phone. It is not a toy. Children could hurt themselves or others (by poking themselves or others in the eye with the antenna, for example). Children could damage the phone, or make calls that increase your telephone bills.

Blasting Areas

To avoid interfering with blasting operations, turn your unit **OFF** when in a "blasting area" or in areas posted: "turn off two-way radio". Construction crews often use remote control radio frequency devices to set off explosives.

Potentially Explosive Atmospheres

Turn your phone **OFF** when in any area with a potentially explosive atmosphere. It is rare, but your phone or its accessories could generate sparks. Sparks in such areas could cause an explosion, causing bodily injury or even death.

Areas with a potentially explosive atmosphere are often, but not always, clearly marked. They include fuelling areas such as petrol stations; below decks on boats; fuel or chemical transfer or storage facilities; and areas where the air contains chemicals or particles, such as grain, dust, or metal powders, and any other area where you would normally be advised to turn off your vehicle engine.

Do not transport or store flammable gas, liquid, or explosives, in the compartment of your vehicle which contains your phone or accessories.

Before using your phone in a vehicle powered by liquefied petroleum gas (such as propane or butane) ensure that the vehicle complies with the relevant fire and safety regulations of the country in which the vehicle is to be used.

Safety Standards

This Cellular Telephone complies with all applicable RF safety standards.

This cellular telephone meets the standards and recommendations for the protection of public exposure to RF electromagnetic energy established by governmental bodies and other qualified organisations, including the following:

- **Verband Deutscher Elektroingenieure (VDE) DIN-0848**
- **Directives of the European Community, Directorate General V in Matters of Radio Frequency Electromagnetic Energy**
- **National Radiological Protection Board of the United Kingdom. GS-11, 1988.**
- **American National Standards Institute (ANSI)/IEEE. C95. 1-1992**
- **National Council on Radiation Protection and Measurements (NCRP). Report 86**
- **Department of Health and Welfare Canada, Safety Code 6.**

Battery Safety

- To prevent injury or burns, do not allow metal objects to contact or short circuit the battery terminals.
- Make sure that the battery terminals do not touch greasy objects.
- Do not immerse the battery in water, or dispose of in a fire.
- Ensure that the battery is disposed of using the proper facilities.
- If you need to replace the battery, make sure that you use only the approved battery type.
- The use of other types of batteries might affect your phone and in such cases the manufacturer assumes no liability.



European Union Directives

Conformance Statement



This product is in conformance with the requirements of the applicable EU Council Directives.







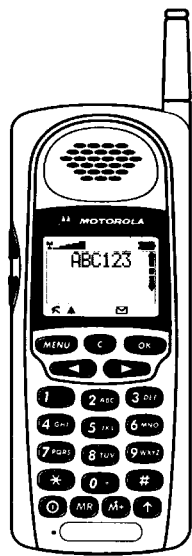

Declarations of Conformance with the requirements are located at:

Motorola Ltd.
European Cellular Subscriber Division
Midpoint, Alençon Link
Basingstoke, Hampshire RG21 7PL
United Kingdom



About Your Phone, Battery and SIM Card



Special Keys



-  Turn the phone on and off.
-  Accept call, setting, option.
-  Access the Quick Access menu.
-  Access the Options menu.
-  Reject call, setting, option.
-  Scroll backwards and forwards.
-  Phone Book lookup; retrieve a number from the Phone Book.
-  Phone Book entry; add a number to the Phone Book.

Volume Buttons



The Volume buttons (up - top, down - bottom) on the left hand side of your phone. The buttons are used for adjusting the keypad, earpiece and ringer volume. A volume meter will display the current volume setting. The meter will disappear after a short time, or if you press  or .

- To adjust the keypad and earpiece volume, press the buttons with no other features selected.
- To adjust the ringer volume, first select the 'Adjust Ring Volume' option in the Phone Setup Menu and then use the buttons to set the required volume.

Locking the Keypad

To prevent accidental usage of the phone, it is possible to lock the keypad. To activate the lock, press the  and  keys simultaneously.

You will be able to answer an incoming call by pressing the  key. The lock will stay on when the call is finished.

To remove the keypad lock, press the  and  keys simultaneously.



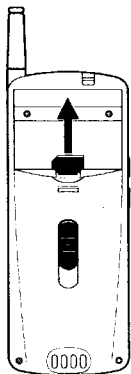

SIM Card Release

The SIM card release button is on the back of your phone. To remove the SIM card, remove the battery, slide the button up toward the top of the phone and pull the SIM card out.

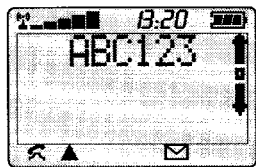

ABC123



Characters are used to display messages and telephone numbers.

Battery Charge Indicator. The more segments displayed, the greater the battery charge.

The Display

The display on your phone shows alphanumeric characters and informative symbols.

The various elements of the display are as follows:



Signal Strength. The more segments displayed in the bar graph, the better the signal strength.



In Use. Displayed when a call is in progress.



Roam. Displayed when you are registered on a system other than your home system.



Short Message Service. Displayed when the phone has received a message. The symbol will flash when your message storage area is full.



Icons are displayed when you are in the Quick Access menu.



A scroll bar will appear on the right of the display when you are in a list/menu. The button on the scroll bar indicates where you are in the list.



Indicates that a menu item is currently selected.

10:20

Real Time Clock. The real time clock can display the time in either a 12-hour or 24-hour format.

In addition, when you are expected to press **OK**, a prompt will appear in the display, for example *Select?*.

Low Temperature Use

The liquid crystal display in your phone behaves differently at extremely low temperatures. The display may respond slowly to key presses; this is normal and does not affect the phone operation in any way.

Your Battery

Looking After Your Phone

! Never leave your phone or battery in extreme temperatures (over 60°C), for example behind glass in very hot, direct sunlight.

To clean your phone, use a moistened or antistatic cloth. Do **not** use a dry or electrostatically charged cloth.

Charging a New Battery

New batteries are supplied in a totally uncharged state.

To ensure maximum battery performance, a new battery (or battery that has not been used for several months) should be charged for at least 14 hours before use.

- !** A new battery will require several full charge/discharge cycles in order to achieve its optimum performance.
- !** A new battery, or a battery that has not been used for several months, may cause a premature fully charged indication. Ignore this indication and let the battery charge for several more hours, remove and re-insert the battery into the charger, and charge for an additional 14 hours.

Battery Design

Your phone is capable of carrying two batteries: the Main and the Auxiliary batteries. These batteries complement each other because as the phone drains one battery, it automatically switches to the other, without losing an active call.

Important Battery Information

- !** Always treat your batteries with care. See 'Battery Safety', at the beginning of this manual.
- !** Never leave your battery in extremely high temperatures (over 60°C), for example behind glass in very hot, direct sunlight.

To ensure that you enjoy maximum battery life and use your battery to its fullest capacity:

The battery should be at or near room temperature when charging.



Handling Batteries

New batteries are supplied fitted with protective covers. These covers must be removed before the battery can be used. Save the covers to carry and store batteries which are not in use. Covers prevent electrically conductive objects from making contact with the battery terminals, thereby reducing the risk of injury or damage from a battery short circuit.



Removing the Main Battery Cover

- 1 Press and hold the release catch.
- 2 Press the battery upwards, out of its cover.

Fitting the Main Battery Cover

- 1 Lower the side of the battery opposite the release catch into the cover.
- 2 Lower the side of the battery with the release catch into the cover, until the catch clicks into place.

Removing the Auxiliary Battery Cover

- 1 Hold the battery securely with one hand.
- 2 With the thumb of your other hand, press the base of the cover upwards. Continue this action until the cover slides free of the pins on the bottom of the battery.
- 3 Swing the cover away, clear of the battery.

Fitting the Auxiliary Battery Cover

- 1 Slide the narrow end of the cover into the small grooved hook on the top of the battery.
- 2 Push the cover firmly upwards until the base of the cover slides past the battery pins; then release.

Battery Performance and Maintenance

- Best battery performance will be achieved when you regularly charge and discharge batteries as instructed in this manual.
- Battery performance is greatly affected by network coverage.
- Set **Battery Saving Mode** to On (see 'Phone Setup Menu') and/or **Frequency of Search** to Slow or Medium (see 'Network Selection Menu').
- Keep the antenna fully extended whenever possible to ensure maximum signal strength.
- If left unused, a fully charged battery will discharge itself in approximately one month.
- When not in use, store your battery uncharged in a cool, dark and dry place.

Low Battery Warning

When the battery level is low and only a few minutes of talk time remain, a warning signal (two double beeps) will sound, the border of the battery symbol will begin to flash, and **Low Battery** will be displayed.

When the battery is completely discharged, your phone will turn off.

If you have an auxiliary battery fitted, it is used before the main battery. A tone sounds when changing to the main battery.

Charging Your Battery Using the Travel Charger

The travel charger can power the phone and charge a fitted battery.

I Ensure that the local mains voltage at your location matches that of your travel charger.

Fit a battery onto your phone. See 'Fitting a Battery to Your Phone', later in this section.

To charge your battery:

- 1 Attach the correct adapter plug to the travel charger.
- 2 Connect the travel charger to the phone.

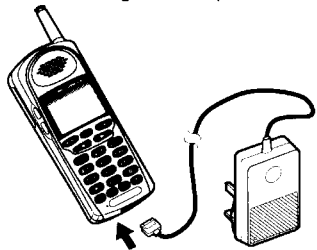

- 3 Insert the travel charger plug into a suitable mains power socket.

A beep-tone is heard and the battery icon flashes when charging begins.

I Your phone can be either on or off during charging.

The state of charging is monitored and displayed by your phone. See 'Battery Indicators' later in this section for details.

Desktop Charging Your Battery

Batteries charge in about 2 to 3 hours, depending on the battery.

I It is normal for batteries to become warm during charging.

Desktop Charger Power Supply

- 1 Connect the travel charger to the desktop charger socket.
- 2 Plug the travel charger into a standard mains socket.

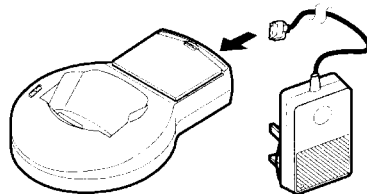

Inserting Your Phone into the Charger

Insert your phone into the desktop charger as shown.

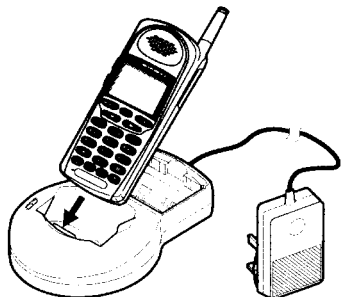

Inserting a Spare Battery into the Charger

A spare main battery or an auxiliary battery can be charged on its own or at the same time as your phone. Insert the battery into the desktop charger as shown.

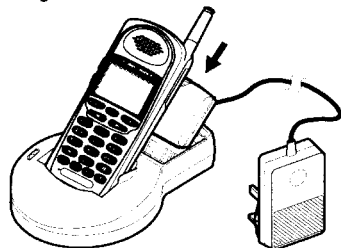

- ☛ For maximum NiMH battery charging, you should double the charge time.
- ☛ Charge times will increase if you make or receive phone calls while charging.

Fitting a Battery to Your Phone

Fitting a Main Battery

Position the battery as illustrated in the following diagram, and snap-lock it into place.

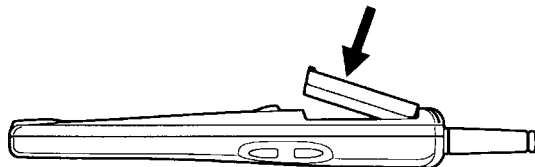

Fitting an Auxiliary Battery

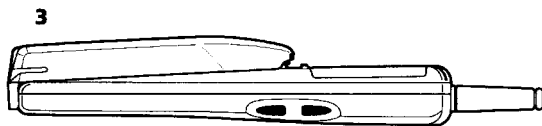
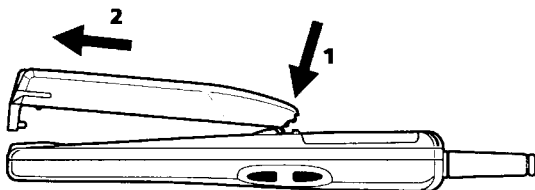

Removing a Battery from Your Phone

Removing a Main Battery

To remove a main battery, press the battery release catch and lift the battery out, away from the phone.

Removing an Auxiliary Battery

To remove an auxiliary battery, slide the battery down until the two catches are released from the base of the phone, and then lift the battery off.

Battery Indicators

Your phone monitors and displays information about your battery. The following messages will appear on the display, as the condition occurs:

Low Battery	The battery charge is low. The battery should be recharged.
-------------	---

Battery Meter Indicators

The battery meter displays different messages depending on the batteries attached, and whether or not there is an external power source. The battery meter is found in the Call Related Features part of the Options Menu.

Not Available	No battery fitted; the phone is operating from external power.
Battery	Only one battery fitted; the phone is operating from this battery.
Aux Battery	Auxiliary and main batteries fitted; the phone is operating from the auxiliary battery.
Main Battery	Auxiliary and main batteries fitted; the phone is operating from the main battery.
Charging Battery	Only one battery fitted; this battery is being charged.
Charging Aux Battery	Auxiliary and main batteries fitted; the auxiliary battery is being charged.
Charging Main Battery	Auxiliary and main batteries fitted; the main battery is being charged.
Fast Charge Complete	All conditions; fast charging is complete.



Your SIM Card

Your SIM (Subscriber Identity Module) card is supplied by your Cellular Service Provider when you buy your phone. You will not be able to make or receive calls without a SIM card inserted in your phone.

 Some networks allow you to make emergency calls without a SIM card inserted.

The SIM card is a 'Smart Card' that contains your phone number, service details and memory for storing Phone Book numbers and messages. You can therefore use your SIM card in someone else's GSM phone and you will be charged for the call.

Like a bank or credit card, you should keep your SIM card secure. Do not bend or scratch your card and avoid exposure to static electricity or water.

 Switch off your phone before inserting or removing the SIM card. Failure to do so may damage the memory on your SIM card.

SIM Card Insertion

Switch off your phone by pressing , remove the battery, and insert the SIM card as shown. If the SIM card is inserted the wrong way round, or damaged, the Check Card message will be displayed. Remove the SIM card, then properly re-insert it into the phone.

If either of the Bad Card See Supplier or Blocked See Supplier messages are displayed, contact your Cellular Service Provider.

SIM Card Removal

Switch off your phone, remove the battery, and push the release button, on the back of the phone, towards the top. Pull the SIM card out.

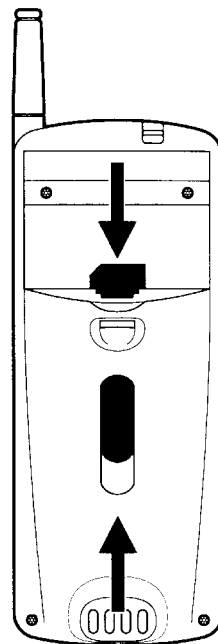

Making and Receiving Phone Calls

Switching the Phone On and Off

To switch the phone on or off press and hold . If VibraCall is selected, the phone will vibrate when it is switched on, except when attached to a power supply or car kit/accessory.

If the phone displays *Insert Card*, there is no SIM card inserted. Once inserted, the phone will check that the SIM card is valid.



A number of messages may appear:

- *Enter PIN* - a request to enter the SIM card PIN code (if required).
- *Enter Phone Unlock Code* - a request to enter the phone unlock code (if required).
- *Searching...* followed by a network name - as the phone finds a suitable network to connect to.

Entering Your SIM Card PIN Code

To enter the PIN code, enter **PIN Code** .

As you type in each digit of the PIN code a * character will be displayed.

If you make a mistake, press  to remove the last digit. Holding  down will remove the entire entry.

When the PIN code is complete press .

If the PIN code is incorrect, the message *Wrong PIN* will be displayed, followed by *Enter PIN*.



 If an incorrect PIN number is entered three times consecutively, your phone will automatically lock-up and the *Blocked* message will be displayed. See 'Unlocking Your Phone' for details.

To change the PIN code, see 'Change SIM PIN Code' in the *Using the Options Menu*.

Entering Your Unlock Code

If your phone displays the message *Enter Phone Unlock Code* you must enter your unlocking code by entering **Unlock Code** .

The unlock code is a four digit number, initially set to **1234**. To change the code, see 'Change Unlock Code' in the *Using the Options Menu*.

If you forget your unlock code, press . This will display the 'Change Unlock Code' option. Enter  **Security Code**, enter a new unlock code, and press .



Making a Phone Call

To make a phone call, your phone must be switched on, unlocked and have the antenna fully extended.

It will not be possible to make a phone call unless you are in an area where there is GSM service. When a service has been found, a series of rising bars, , will show the signal strength.

There are a number of ways to make a phone call:

- Using the digit keys.
- Using automatic redial.
- Dialling numbers from the Phone Book*:
 - using one-touch dialling,
 - using an entry from a location,
 - using an entry of a name,
 - using one of the last ten numbers called.
- Calling an embedded number in a message.

 *Your phone contains a 'phone book' that can be used to store names and telephone numbers. See **OK What is the Phone Book?** for further details.

Keypad Digits

The simplest method of making a phone call is to enter the number using the digit keys, then press **OK**.

 If you make a mistake, press and release **C** to remove the last digit. Holding **C** down will remove the entire number.

The display will show **Calling** when the call is being made. If there is no answer, press **OK**, or close the phone to end the call.

When the call is answered, the display will change to **Connected** for a few seconds, followed by **End Call?**.

To end your call press **OK**, or **C**.

Automatic Redial

If your call attempt does not succeed, the message **Redial?** will be displayed for five seconds. Pressing **OK** at this point will automatically redial the phone number.

When the call is answered, you will hear a short ring tone.

The maximum number of redial attempts is set by your Cellular Service Provider. If the phone call cannot be connected within this maximum, the message **Redial Failed** will be shown.

Phone Book Dialling

OK One-touch

To quickly retrieve and dial a number stored in the first nine locations of your Phone Book¹, press and hold the appropriate digit key. For example, pressing and holding **2** will dial the number stored in location 2 of your Phone Book.

 You do not need to press **OK** to call the number.

By Location

1 Press **MIR** and a location number. For example **MIR 2 23** will retrieve the number stored in location 23 of the Phone Book.

*If you don't know the exact location, enter a random location and then use **◀** and **▶** to scroll to the number. Location numbers are from 1 to 255.*

2 Press **OK** to call the number.

By Name

You can also dial a number in the Phone Book associated with a name entry.

1 Press **↑** **OK** and enter the first letter of the name.

2 Scroll through the alphabetically listed names using **◀** and **▶**.

3 Press **OK** to call the number of the selected name.

Last Ten Calls

 When in standby mode, press **OK** and scroll through the numbers. Press **OK** to make the call.

Alternatively, you can retrieve the last number dialled using the 'Last Ten Calls' feature in the Phone Book menu.

Calling an Embedded Number in a Message

Details on how to call a number embedded in a message are given in the **Messages Menu** section.

International Phone Calls

To make an international phone call press and hold the **0** key. After a couple of seconds the international dialling prefix + will appear in the display, this allows you to call from any country without knowing the local international access code.

Now enter the country code, followed by the phone number. The country code follows the conventional format, 49 for Germany, 44 for the UK, 46 for Sweden, etc.

Just like a conventional international call, remove the leading '0' of the area code when you dial.

Inserting Pauses Into Phone Numbers

To obtain a three second 'pause' character in a phone number, press and hold ***** for a couple of seconds, the pause symbol  will appear.

This symbol produces a three second delay whenever it is used. However, the first pause character in a phone number is a special case: it allows the call to be answered before dialling the remaining digits.

1. The Phone Book entries that you are able to access will depend on the One-Touch Dial Setting option in the Phone Book menu.

Pause - A Working Example.

If, for example, if you have a tone-based voicemail system on 555-6911, with a mailbox number 1066 and password 2001. Then you may dial the following number:

5556911=1066=2001 **OK**.

The first part of the number is used to call the voicemail system.

When the call is answered the first pause will produce a delay of three seconds before the tones for 1066 are sent to select the mailbox.

There will be a second pause of three seconds before the tones for 2001 are sent as the password.

GSM Emergency Calls

The worldwide GSM network provides a standard number, 112, to dial in cases of emergency.

Provided that your phone has found a network, you will be able to make an emergency call. The call can be made regardless of any security codes and, depending on the network, with or without a SIM card inserted.

The emergency call will be directed to a central emergency operator.

To dial the GSM emergency number, press

1 1 2 **OK**

While the emergency call is being made and connected, the display will show *Emergency Calling*.

Receiving a Phone Call

To receive a phone call:

- Your phone must be switched on and unlocked.
- You must be in an area where there is GSM service.
- Your Call Diversion and Call Barring settings should not be set to divert or bar incoming calls.

When your phone receives a call, it will ring or vibrate. To answer the call, extend the antenna and then press **OK**. If your network supports Caller Line Identification (CLI), the caller's number or name will be displayed, depending on your Phone Book entries.

Your phone automatically searches in the Phone Book for the caller's number. If the number is found, then the name entry associated with the number is displayed. If the number is not found, or if it is but there is no associated name in the Phone Book, then the caller's number is displayed.

If you do not want to answer the call, you can:

- Press and release **C**.

The caller is either diverted to a forwarding number or hears a busy tone, depending on your features settings.

or

- Press and hold **C**. This will reject the incoming call. No call divert option will be offered in this case.

If your phone rings and you do not answer it, the message **Unanswered Call** will be displayed so that you know someone tried to call you.

Ending a Phone Call

To end a phone call, press **OK**.



Security Features

You may find that you are prompted to enter certain security or access codes before you can use your phone or some of its features. These codes are:

- PIN Code (SIM card PIN code).

Prevents access to your SIM card. The number is supplied by your service provider. Your SIM card will be blocked if three unsuccessful attempts to enter this number are made.

- PIN2 Code.

Prevents access to certain advanced features. The number is supplied by your service provider.

- Unlock Code.

Protects your phone from unauthorized use. The default code is 1234.

- Unblock Code.

Unlocks your SIM card if it has been blocked by three unsuccessful attempts to enter the PIN code. The number is supplied by your service provider.

- Security Code.

Prevents access to security features. The default code is 000000.



Menu Navigation

A large number of your phone's options are accessed by using menus which use a common approach for selection, change and cancellation.

Please read this section carefully before attempting to access a menu option. When you understand the common approach to menu navigation and how the menus are shown, you will be able to access and change options with ease.





The menus described here can only be accessed when the phone is in the standby mode. Menu operation is not possible when you are making or answering a phone call.

Entering the Menus



Two different keys are used to access the menus:

 accesses the Options menu.

 accesses the Quick Access menu.

Once entered, the menus use the , , ,  and  keys in a common manner to access and change individual options.

Leaving the Menus

To leave any of the menus, you can either press and hold  or repeatedly press . Both of these actions will return your phone to the stand-by mode.





 Alternatively, a quicker way to leave the menus is to press

 .

Menus and Sub-menus

A menu is a simple list of options. Some of these options provide access to a further list of options called a sub-menu. When navigating through the menus you may find it helpful to think in terms of menu levels - the 'parent' menu being on one level and its sub-menu being on a lower level.

Moving to and Selecting a Menu Option

To move from one option to another on the same level, use the scroll keys:  and  scroll forwards and  scrolls backwards. When you find the option you want, press  to select it.

Depending on the option you select, one of three things will happen:

- either a brief message will be displayed confirming an action, for example **Completed**.
- or a prompt will be displayed requesting you to enter information, for example **Enter PIN** or **Enter Name**.
- or the first option of a sub-menu will be displayed. You can select this option using  or browse through the other options using the scroll keys.

To leave an option or sub-menu, press . This will take you back to the parent menu item.

Menu Options with Security Codes

Some options are protected from misuse by requiring you to enter one of the security codes. In order to use these options, you must enter the requested code before proceeding.



Menu Navigation - A Working Example

The following steps will take you through how to switch the Extended Menus option on:

- 1 When the phone is in the stand-by mode, press **MENU**. This will access the Options menu and Phone Book will be displayed.
- 2 Press **▶** three times to go to the Phone Setup menu item.
- 3 Press **OK** to select the sub-menu. The display will now show the Adjust Ring Volume menu option.
- 4 Press **▶** repeatedly until the Extended Menus sub-menu item will be displayed.
- 5 Press **OK** to select this item. You can now select between On or Off, the current setting will be shown with a ✓ character. If the ✓ character is next to Off, press **▶** and then **OK** to switch Extended Menus on. If the ✓ character is next to On, press **◀** to leave the setting as it is.

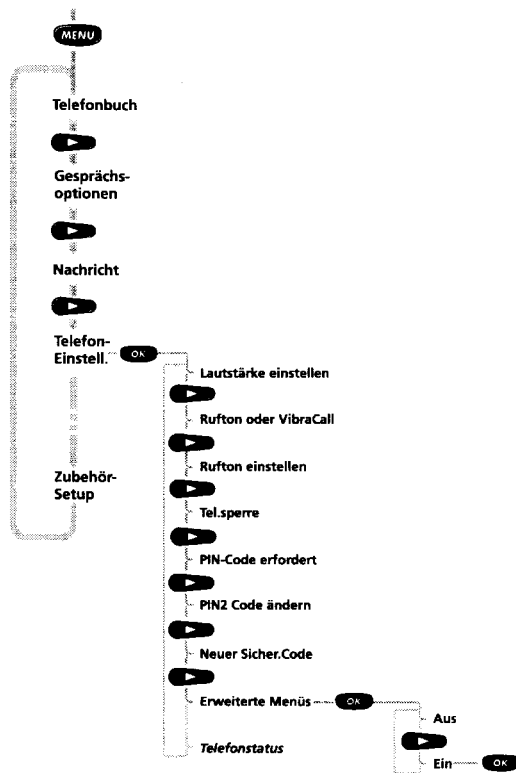

OK *Personalising the Menu*

With *Personality*TM you can personalise the menus by choosing which features you want readily available. Less frequently used features can be stored out of sight. The menu diagrams in this manual show the default conditions of the menu settings when you first receive your phone.

- Short menus contain those items which are used most often. The default items are shown in **bold** type in this manual.
- Extended menus contain those items which are used less often. The default items are shown in *italics* in this manual.

You can change which items are active in the short and extended menu. In this way, you can decide which items are displayed as you scroll through a menu.

To move an item from the short menu to the extended menu (or from the extended menu to the short menu), select the item and hold down **OK** until a prompt appears offering the following choices:

- Remove From Short (Extended) Menu
- Leave in Short (Extended) Menu

Select the option you want by pressing **OK**.

 *The settings for some menu features cannot be changed.*





Using the Options Menu

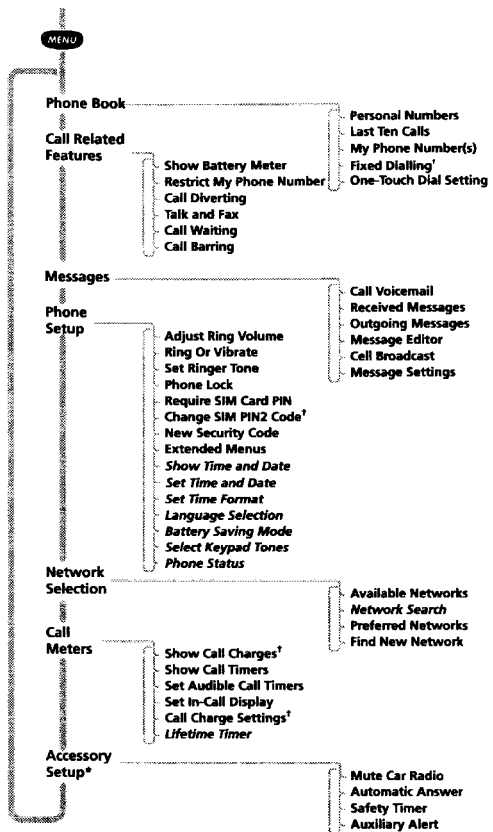

Scrolls down (forwards) through the menu list.



Scrolls up (backwards) through the menu list.



Selects the sub menu, or accepts an option.



Scrolls to the parent menu, or cancels an option.



Once in the Options menu, **MENU** can be used as an alternative to



Menu Navigation



Items shown in *italics* are available only when **Extended Menus** are switched on.

† Availability depends on the type of SIM card.

Using the Options Menu

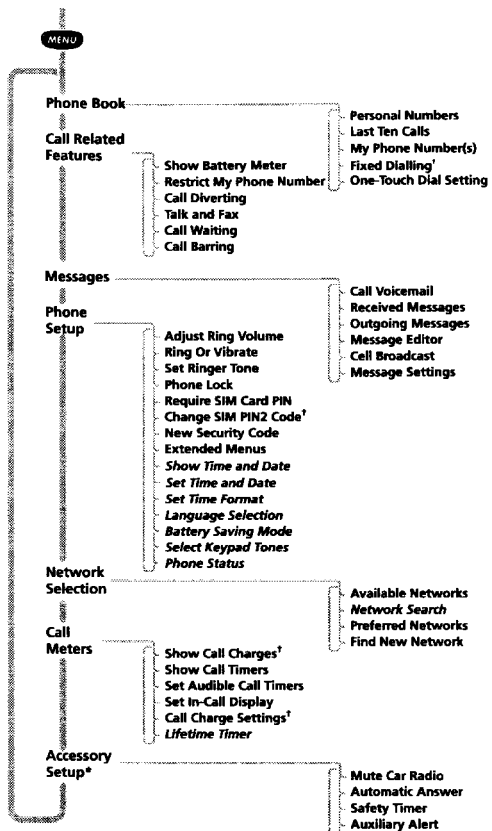

Scrolls down (forwards) through the menu list.



Scrolls up (backwards) through the menu list.



Selects the sub menu, or accepts an option.



Scrolls to the parent menu, or cancels an option.

Once in the Options menu, **MENU** can be used as an alternative to



Menu Navigation



Items shown in *italics* are available only when **Extended Menus** are switched on.

† Availability depends on the type of SIM card.

OK *What is the Phone Book?*

You can store names and telephone numbers as entries in an electronic 'Phone Book'. These entries are stored in the *Personal Numbers list* in your phone or SIM card's memory, and in the *Fixed Dial list*¹ on your SIM card. Once stored, a number can be quickly retrieved and dialled.

Your Phone Book storage capacity is as follows:

	Phone Memory	SIM Card Memory^a
Personal numbers	100 entries	155 entries
Fixed dial numbers	None	20 entries
Phone number digits	32	20
Name characters	16	10-50
Locations	1-100	101-255

- a. SIM card capacity varies depending on the cellular service provider.

Postscripting

This allows you to make use of area codes and other prefixes previously stored in your Phone Book when making a call.

To use postscripting, select the Phone Book entry containing the prefix and then simply enter the rest of the number and press  to make the call.

You can also use postscripting if you want to call a number similar to one you have stored in your Phone Book. Retrieve the number from the Phone Book, delete the relevant digits and then enter the new number.

 *Postscripting a number does not overwrite the entry in the Phone Book.*

1. Availability of the Fixed Dialling feature depends on the type of SIM card you have.

How to Enter Alphabetic Characters

The **0**, **1**, ..., **8** and **9** keys are used to enter alphabetic characters, for example when storing names in the Phone Book or when creating messages.

For example, if you press **5**, the first displayed character will be J. If this is not the required character, then you can press the same key again to show K. Another press will display L, another... will display 5. Your phone will continue to scroll through the characters available on the selected key with each new key press.

A long press of any of the keys will switch all the characters to lower case, a second long press will switch back to upper case.

To enter the next character press the appropriate key. If, however, the next character is on the same key as the previous character you will first need to press **▶**. Pressing **▶** a second time will produce a space.

If you make a mistake, you can go back to the incorrect character by pressing **◀**.

Characters can be removed from the display by pressing **C**.

The character before the cursor (■) is the character which will be deleted.

Press **OK** to store the information.

Available Characters

Press the appropriate keys to get the following characters:

1	SPACE . ? ! , @ & : " () ' & i % € \$ 1 SPACE . ? ! , @ & : " () ' & i % € \$ 1
2 ABC	A B C Ä Å Æ Ø 2 a b c ä å æ ø 2
3 DEF	D E F Ö É Ê Ë 3 d e f ö é ê ë 3
4 GHI	G H I ı 4 g h i ı 4
5 JKL	J K L Å 5 j k l Å 5
6 MNO	M N O Ö Ø 0 6 m n o ö ø 0 6
7 PQRS	P Q R S ı 7 p q r s ı 7
8 TUV	T U V ı 8 t u v ı 8
9 WXYZ	W X Y Z ı 9 w x y z ı 9
0	+ - × * / = > < # 0 + - × * / = > < # 0

The top line for each key shows the upper case characters, the lower line shows the lower case.



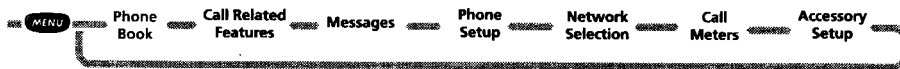

The Phone Book Menu

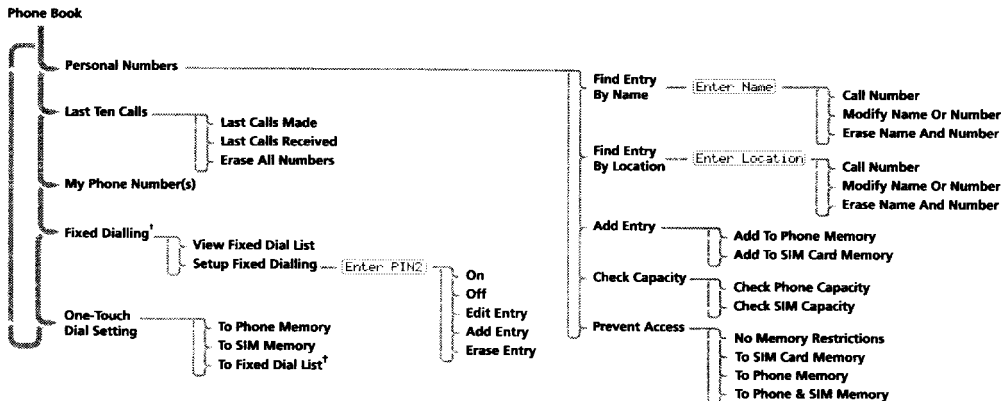

Menu Navigation



† Availability depends on the type of SIM card.

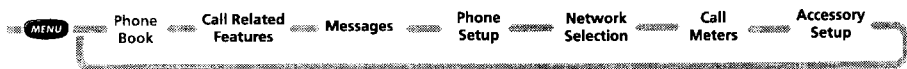

Personal Numbers

The Personal Numbers sub-menu is used for creating and managing your list of personal numbers.

Find Entry By Name

This option is used to select a phone number from a list of alphabetically sorted Phone Book names.



Once selected, this option will display the message *Enter Name*. You can enter the first three characters of a name. You do not need to enter all three characters, but a longer entry will result in a more accurate search.

The Phone Book entries will be searched and the first matching entry will be displayed.

If there isn't a name matching your entry, the nearest matching entry will be displayed.

If you do not enter any name information, the first alphabetical entry will be displayed.

If there are no names stored, *No Names Stored* will be displayed.

To display adjacent Phone Book entries use  and . When the desired name is displayed press  to select it. The phone will now enter the 'Call Number', 'Modify Name Or Number' or 'Erase Name And Number' options sub-menu.

Find Entry By Location

 Press  *Location*.

This option is used to select a phone number from a list of numerically sorted Phone Book locations.



Once selected, this option will display the message *Enter Location*. You can now enter a location number. If the entered location is not valid, a timed message *Range 1-XXX* will be displayed and the phone will return to the *Enter Location* menu item.

The Phone Book entries will be searched and an entry will be displayed.

If you enter a location number for which there is no entry, *Location Empt* will be displayed and the nearest non-empty location will be selected instead.

If you did not enter a location, the first numerical entry will be displayed.

If there are no numbers stored, *No Numbers Stored* will be displayed.

To display adjacent Phone Book entries use  and . When the desired name is displayed press  to select it. The phone will now enter the 'Call Number', 'Modify Name Or Number' or 'Erase Name And Number' options sub-menu.

Alternatively...

You can also select a number from a Phone Book location using . See 'Making and Receiving Phone Calls'. You can do this even if you are not in the Phone Book menu.

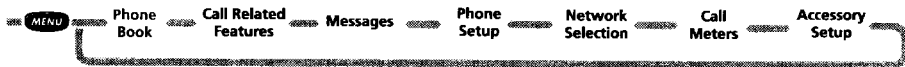

Call Number, Modify Name Or Number or Erase Name And Number Options

Once a Phone Book entry has been selected, it can be called, modified or deleted.

Call Number

This option is used to call the selected Phone Book telephone number.

Modify Name Or Number

This option is used to change the selected Phone Book entry.

The entry's current telephone number and name will be presented, in turn, for modification. You can accept the current settings or modify as required.

Erase Name And Number

This option is used to erase the selected Phone Book entry.

Simply press **OK** when the phone displays the message `Erase Name And Number`. The option will display the timed message `Erased XXX` and then return to the `Find Entry` menu item.

Add Entry



This option is used to add (store) entries to the Phone Book. You can choose to add the new entry to either the phone or SIM card memory locations.

Add To Phone Memory, Add To SIM Card Memory

Once you have selected the destination of the new entry, enter the phone number, name and location number of the new entry.

The last telephone number displayed will be presented by default; it can be used or discarded as required.

If the entered location is not valid, a timed message `Range YYY-ZZZ` will be displayed and the phone will return to the `Enter Location` prompt. If the chosen location is currently used by another entry, you will be asked for confirmation that the location can be overwritten.

If you do not supply a location number, the next available location will be used.

When the new entry has been entered, a timed message `Stored XXX` will be displayed.

Alternatively...

You can add entries to the Phone Book using **M+**. You can do this even if you are not in the Phone Book menu. Press **OK** to add the new entry to the phone memory, or press **▶** **OK** to add it to the SIM card memory. Then, enter the phone number and name of the new entry, and confirm or set the location number. The message `Stored` appears when the entry is complete.

Check Capacity

This option is used to check the number of free Phone Book entries in the phone or SIM card memory areas.

Check Phone Capacity, Check SIM Capacity

Once selected, a timed message `XX Unused Locations` displays the requested information.

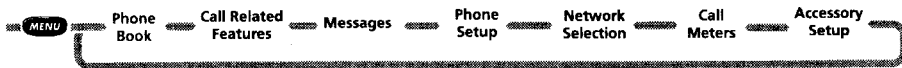

Prevent Access

This option enables you to prevent access to the Personal Numbers list.

To SIM Card Memory, To Phone Memory, To Phone & SIM Memory, No Memory Restrictions

You can prevent access to all entries in the SIM card memory, the phone memory or both the phone and SIM card memory. To cancel all access restrictions use the No Memory Restrictions option.

When you change the restrictions, you will be requested to enter the Security Code before the change is made.

Last Ten Calls

These options can be used to call the most recently used phone numbers.

Once an option has been selected, use and to scroll through the list of phone numbers. Press to call the displayed number.

You can use postscripting to modify a number once you have retrieved it from either of the Last Ten Calls lists.

Last Calls Made

This option can be used to redial the phone number of any one of the last ten calls made.

Last Calls Received

This option can be used to redial the phone number of any one of the last ten calls received.

You will only see numbers in the Last Calls Received list if you have Caller Line Identification.

Erase All Numbers

This option erases all the numbers stored in your Last Ten Calls Made and Last Ten Calls Received lists.

My Phone Number(s)

Press

This option allows you to access your cellular phone, fax and data numbers so that you can retrieve or modify them when required. For example, if you have difficulty remembering your cellular phone number, store it with the name My Phone and then you will be able to retrieve the number as required.

The My Phone Number(s) list is stored on your SIM card.

When you select this item, the first location will be displayed. Use and to scroll through the phone numbers stored.

To enter or change a number, scroll to the location and press . You will be prompted to enter a phone number and then a name. Press to store the information.

Depending on your Cellular Service Provider, you may find that one or more of the entries in the My Phone Number(s) list will have been defined. You may not be able to change these predefined entries.

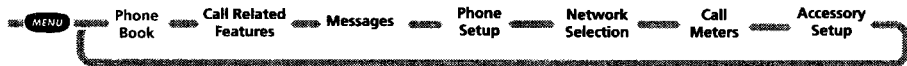

Fixed Dialling

 Availability of the Fixed Dialling menu depends on the type of SIM card.

This feature allows you to limit use (typically third-party use) of your phone to a predefined list of phone numbers or, if you wish, to a list of country codes, area codes, or other prefixes of your choosing.

When Fixed Dialling is switched on, the only numbers that can be dialled from your phone are those stored (or whose prefix is stored) in the Fixed Dial list. If you attempt to dial any other number (apart from an emergency number), the message **Restricted** will be displayed. You will not be able to make fax or data calls.

To make a call when Fixed Dialling is switched on, either dial the number manually, or select it from the Fixed Dial list and press

.

Up to 20 entries can be stored in the Fixed Dial list. The list is stored on your SIM card.

 This option may be affected by the Call Barring setting.

View Fixed Dial List

This option allows you to scroll through the numbers in the Fixed Dial list. When you find the number you want, press  to make the call.

Setup Fixed Dialling

This option allows you to switch Fixed Dialling on or off and to enter or change entries in the Fixed Dial list.

You will be prompted to enter your PIN2 security code when you select this option.



On

Switches fixed dialling on.

Off

Switches fixed dialling off.

Edit Entry

Modifies or clears an entry in the Fixed Dial list. When you select this option, the first non-empty location in the list will be displayed. Scroll to the entry you want to change and press . You will be prompted to edit the phone number and the name. To erase the entry, press .

Add Entry

Adds a phone number and name to the Fixed Dial list. When you select this option you will be prompted to enter the phone number, name and a location number. If you do not specify a location number, it will be stored in the next available location.

 When setting up your Fixed Dial list, you may want to reserve the first nine locations for phone numbers you wish to One-Touch Dial. See also 'One-Touch Dial Setting'.

Erase Entry

Erases a phone number and name from the Fixed Dial list. The first entry in the fixed dial list will be displayed. Scroll to the entry you wish to delete and press .

One-Touch Dial Setting

This option allows you to specify which Phone Book list can be One-Touch Dialed.

To Phone Memory

Switches One-Touch Dialling to your Personal Numbers list stored in phone memory (locations 1 to 9).

To SIM Memory

Switches One-Touch Dialling to your Personal Numbers list stored on your SIM card (locations 101 to 109).

To Fixed Dial list

 *This option is only available if you have Fixed Dialling.*

Switches One-Touch Dialling to your Fixed Dial list (locations 1 to 9).



Call Related Features Menu

Call Related Features

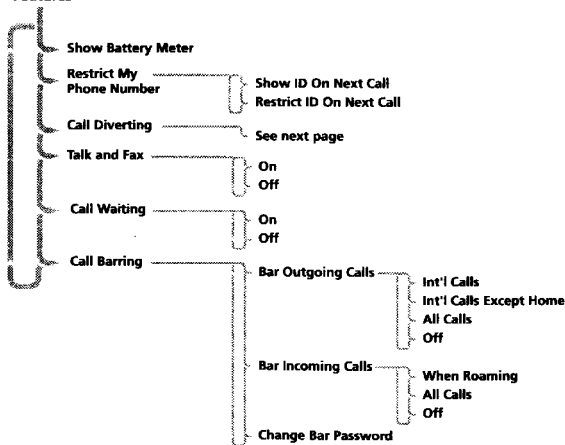

Menu Navigation



Show Battery Meter

This option displays the approximate amount of battery capacity remaining, for example:

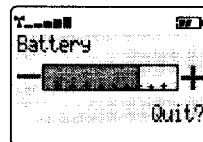

See 'Your Battery' in the section, *About Your Phone, Battery and SIM Card* for other information displayed about the battery meter.

Restrict My Phone Number

'Restrict My Phone Number' is a network feature. You will need to subscribe to one of the two Caller Line Identification restriction features with your Cellular Service Provider.

Show ID On Next Call

Your phone number is sent with the next attempted call, after this your phone number will not be sent until you re-select this option.

Restrict ID On Next Call

Your phone number will not be sent with the next attempted call, after this your phone number will be sent with calls until you re-select this option.

OK Call Diverting

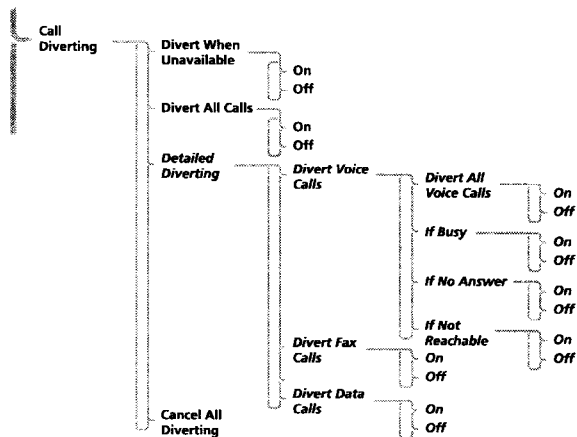

Call diverting is a network feature. If your phone is unavailable, or you do not wish to receive calls, incoming calls can be diverted to other phone numbers.

This option can be used to:

- Divert all incoming calls unconditionally.
- Divert incoming calls whenever your phone is unavailable.
- Divert calls to different numbers, depending on the call type and the current status of your phone.
- Reset all diversion options to off.

You cannot change the call divert settings when you are out of GSM coverage.

After selecting any of the call divert options there will be a short delay while the phone asks the network for the current setting.

Divert When Unavailable

This option will enable you to divert all incoming calls to a single number, whenever your phone is unavailable.

The option has two settings, **On** or **Off**.

If you change the setting to **On**, you will be asked to enter a diversion phone number using the digit keys.

When **On**, *Divert When Unavailable* takes priority over detailed diversion settings.

Divert All Calls

This option will enable you to *unconditionally* divert all incoming calls to a single number.

The option has two settings, **On** or **Off**.

If you change the setting to **On**, you will be asked to enter a diversion phone number using the digit keys.

When **On**, *Divert All Calls* takes priority over all other diversion settings.

Detailed Diverting

These options will enable you to divert calls to different numbers, depending upon the call type and the current status of your phone.

Each of the following detailed diverting options operate in the same way.

Each option has two settings, On or Off.

If you change the setting to On, you will be asked to enter a diversion phone number using the digit keys.

 Detailed diversion settings are ignored while Divert All Calls or Divert When Unavailable are On.

Divert Voice Calls

Divert All Voice Calls

When selected, this option will unconditionally divert all incoming calls. You will have no opportunity to answer an incoming call.

If Busy

This option will divert incoming calls if your phone is busy.

If No Answer

This option will divert incoming calls if you do not answer the call.

If Not Reachable

This option will divert incoming calls if your phone cannot be contacted by the network.

Divert Fax Calls, Divert Data Calls

When selected, these options will divert incoming 'Fax' and 'Data' calls.

Cancel All Diverting

This option will enable you to cancel the diversion of incoming calls.

 This option resets all diversion settings to Off and removes all diversion numbers.

Talk and Fax

This is a network feature that allows you to speak and then send or receive a fax during the course of a single call, using a PC (PCMCIA) card. Refer to the **Accessories** section for more information about the PC Card.

 Your phone supports a data and fax transmission speed of up to 9600 bps.

Before making a Talk and Fax call, ensure that:

- Your phone is "fax-ready" (it has been switched off, connected to the PC card, then switched back on). Connecting your phone to the PC card in the middle of the call will not work.
- The Talk and Fax mode is set to On.

A Talk and Fax call automatically switches to fax mode when you start sending the fax. While the fax is being transmitted, the message **Fax in progress** will be displayed. The call automatically ends when the fax transmission is complete. You cannot switch back to voice mode in the same call.

 While a Talk and Fax call is active, Call Waiting is suspended.

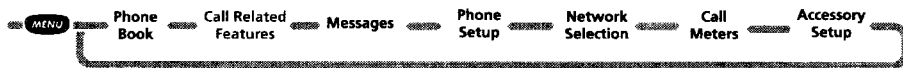

If you receive a Talk and Fax call when:

- Your phone is not fax-ready - you can only talk.
- Your phone is fax-ready but Talk and Fax mode is off - the call is automatically routed to your fax (you cannot talk).

On

Switches Talk and Fax mode on for the next and all subsequent calls.

Off

Switches Talk and Fax mode off for the next and all subsequent calls.

OK Call Holding and Call Waiting

Your phone supports the GSM network options of Call Holding and Call Waiting. Using these options you can place a current phone call on hold and accept an incoming call or start a second call.

The Call Waiting menu item has two settings On or Off. If you select Off, you will be not be notified of waiting calls. The person trying to contact you will either receive the busy tone, or be diverted by the 'Detailed Diverting - If Busy' option.

If Call Waiting is On, you will be notified of a waiting call by an audible alert and by the message **Call Waiting - Answer?** You can press **OK** to accept the waiting call, or use **MENU** to scroll to an alternative option and then press **OK**.

Info If you have Caller Line Identification, the caller's number or name is displayed instead of the Call Waiting message.

Call Holding and Call Waiting Scenarios

The display will automatically change according to the status of your current call (or calls) and will propose the option that you are most likely to want. Press **OK** to accept this option or press **MENU** to scroll through the alternative options. By following this procedure you will find that even the triple combination of an active call, a held call, and a call waiting is easy to manage.

The following points summarise the more common situations:

- To end the active call, press **OK**. If you have a call on hold it is automatically connected.
- To put the active call on hold and make another call, press **MENU** and select the **Hold Call** option, then press **MENU** again and select the **Make New Call** option¹.
- To put the active call on hold and reconnect a held call, press **MENU** and then select the **Switch Calls** option.
- To accept a waiting call, press **OK**. The active call will be placed on hold. If you prefer to end the active call before accepting the waiting call, press **MENU** and select the **End Active Call** option, or **End Held Call** option as appropriate.
- To reject a waiting call, press **MENU** and select the **Reject Call Waiting** option (or simply press **C**).

1. A quicker method of making another call is to enter the number to be called directly. As soon as you press the first digit, the display will change to **Call?**. This will disappear three seconds after the last key press, but if you press **OK** before then, your phone will place the current call on hold and attempt to call the number entered.

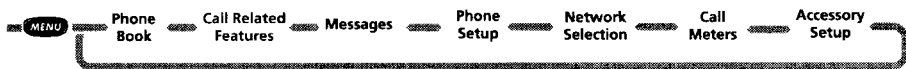

 If you have an active call, a call on hold and a call waiting, you cannot accept the waiting call until you end either the active call or the held call.

Call Holding and Call Waiting Messages

During Call Holding and/or Call Waiting operations, your phone may display one or more of the following messages:

Trying

A request to hold the active call, or swap the active call with a held call, has been made.

or

A request to reconnect the held call has been made.

Hold Failed

The request to hold a call has been unsuccessful.

Cannot Hold Second Call

A call is already on hold, you cannot place two calls on hold at the same time.

Reconnect Failed

The held call could not be made active again.

Busy Try Later

Your phone is still working on a previous command. Wait a short time before repeating the command.

Anonymous

The person who is calling you has blocked their number from appearing on your phone.

Unavailable

The network is unable to provide the caller's number.

Call Barring

Call barring is a network feature which can be used to selectively bar outgoing and incoming calls.

If you change the barring setting, you may be asked to enter your barring password. There will be a short delay while the phone notifies the network of the new setting. When the change has been made by the network, the phone will display a confirmation message.

The *initial* password will be supplied to you by your Cellular Service Provider when you subscribe to this service.

 This option may be affected by the Fixed Dialling setting.

Bar Outgoing Calls

After selecting this option, there will be a short delay while the phone asks the network for the current setting.

Int'l Calls

When selected, this option will bar outgoing international calls.

Int'l Calls Except Home

When selected, this option will bar outgoing international calls, except those to your home country.

All Calls

When selected, this option will bar all outgoing calls, except emergency calls.

Off

When selected, this option will disable all call barring for outgoing calls.

Bar Incoming Calls

After selecting this option, there will be a short delay while the phone asks the network for the current setting.

When Roaming

When selected, this option will bar incoming calls when you are roaming.

You may wish to select this option, as some Cellular Service Providers charge an additional fee for receiving calls when you are roaming.

All Calls

When selected, this option will bar all incoming calls.

Off

When selected, this option will disable all call barring for incoming calls.

Change Bar Password

This option can be used to change the call barring password.

After selecting this option, you will be asked to enter the current password.

You will then be asked to enter, and then re-enter, your new, **4 digit**, barring password. When the change has been made by the network, the phone will display a confirmation message.



Messages Menu

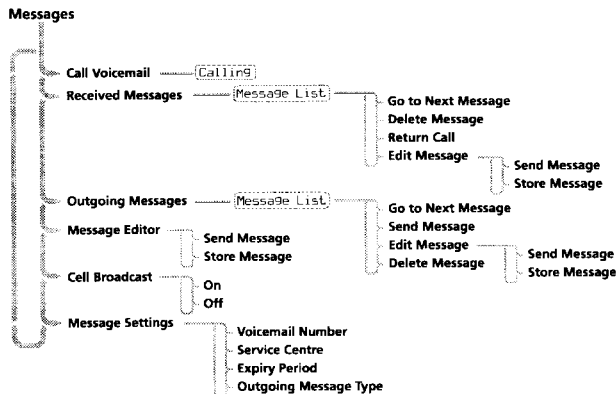

Menu Navigation





Overview of Messages and How to Use Them

Your phone supports the two GSM message features: Short Message Services (SMS) and Cell Broadcast.

SMS Messages

These are text messages that are sent specifically to and from your phone number.

When an SMS message is received, your phone:

- 1 Makes three short alert tones (depending on the 'Ring or Vibrate' setting).
- 2 Displays the  (messages) icon.
- 3 Stores the message for later viewing, if there is space. If there is not enough space, the  icon will flash. One or more messages must be removed before the message can be stored.

Your Cellular Service Provider will transmit a message for a limited amount of time. If a memory location is not made available before the message is removed from the network, then you will not be able to receive or read it.



Cell Broadcast Messages

These are general messages, broadcast to a group of phones and can only be received when your phone is in standby mode.

These messages are broadcast in numbered 'channels' and, in general, each channel will tend to carry one particular type of information.

Typical cell broadcast channels could have information on local weather conditions, traffic reports or stock market prices. Please contact your network operator for a list of available channels and the information they supply.

When the message has scrolled across the display, the beginning of the message will be shown until you either remove it or a new message arrives.

How to Read SMS Messages

You can use the scroll keys (**MENU**, **▶** and **◀**) to scroll through messages in either the Received Messages or Outgoing Messages lists.

To display a specific message, enter the message number, for example press **5** to display the 5th message. If the message does not exist, *Invalid Msg Number* will be displayed.

Alternatively, to display the next message, press **OK** and select *Go To Next Message*.

How to Create and Edit SMS Messages

Use the *Message Editor* to create or modify text messages. When you enter the editor, the last message that was edited will be displayed. Press and hold **C** to clear the message and start a new one, or modify the message displayed. For an explanation of how to enter text, see 'How to Enter Alphanumeric Characters' in the **OK** *What is the Phone Book?* section.

Press **OK** once you have completed your message. You will then be presented with the following options:

Send Message - If you select this option you will be prompted for a phone number, enter the number and then press **OK** to send the message.

Store Message - Select this option to store your edited message in your Outgoing Messages list.

⚠ *If you don't store the message after it has been edited, you will lose all your changes as soon as you select another message to be edited.*

OK Call Voicemail

Once selected, this option will leave the Messages menu and automatically make a phone call to the current voicemail number. The display will show *Calling* and standard call operations can be performed.

The voicemail phone number can be entered by selecting the 'Voicemail Number' option in the 'Message Settings' sub-menu.



Received Messages

This option is used to view and manage any SMS messages that have been sent to your phone number.

When selected, this option will display a message indicating the total number of messages and how many of these are new. If there are no messages **No Messages** will be displayed.

If there are messages, the new messages will be displayed first, followed by the old. Repeated presses of **MENU** will display the whole message, when it was sent and the phone number who sent it (if available).

Once you have read a new message it will automatically become old.

See 'How to Read SMS Messages' for more information on navigating through the messages.

Press **OK**, when viewing any message, to enter the 'Go to Next Message', 'Delete Message', 'Return Call' and 'Edit Message' sub-menu.

Go to Next Message

This option will display the next received message.

If you are currently reading the last message in your list then this option will take you back to the top of the list.

Delete Message

This option will delete the currently viewed message

Return Call

This option can be used to call the person who sent you the message, if their number has been included by the network, or a number that has been included in quotes "" in the message.

Edit Message

This option allows you to use the Message Editor to edit the selected message and then to either send the modified message and/or store it in your Outgoing Messages list. See 'How to Create and Edit SMS Messages' for more information on using the Message Editor.

Outgoing Messages

This option is used to view and manage any outgoing messages. These messages will be stored on your SIM card. When you select this option, the total number of messages will be displayed followed by the first message in the list.

 You cannot send an outgoing message until the Message Service Centre number has been set. See 'Message Settings'.

Press **OK**, when viewing any message, to enter the 'Go to Next Message', 'Send Message', 'Edit Message' and 'Delete Message' sub-menu. See 'How to Read SMS Messages' for more information on navigating through the messages.

Go to Next Message

This option will display the next outgoing message.

Send Message

If you select this option you will be prompted for a phone number, enter the number and then press **OK** to send the message.



Edit Message

This option allows you to use the Message Editor to edit the selected message and then to either send the modified message or store it in your Outgoing Messages list. See 'How to Create and Edit SMS Messages' for more information on using the Message Editor.

Delete Message

This option will delete the currently viewed message.

Message Editor

The Message Editor is used to edit the currently selected message and then to either send the modified message or store it in your Outgoing Messages list. See 'How to Create and Edit SMS Messages' for more information on using the Message Editor.

Cell Broadcast

This option is used to set the cell broadcast settings. The option has two settings On or Off.

If you change the setting to On, you will be asked to enter the channel you wish to receive information from.

Please contact your Cellular Service Provider for a list of available channels and the information they provide.

While a broadcast message is scrolling across the display you can stop and start it by pressing . Press to restart the message from the beginning. If you want to remove the message from the display, press .

Message Settings

Voicemail Number

This option is used to enter a phone number which will be used by the 'Call Voicemail' option.

If there is already a Voicemail Number, this will be shown in the display. This can be used, modified or deleted as desired.

Service Centre

Before you can send any messages you must use this option to enter your Message Service Centre number. This number is obtained from your Cellular Service Provider.

Expiry Period

You can use this option to specify the maximum time, in hours, that your unforwarded messages are to remain with the Message Service Centre before being deleted. When you select this option, the current expiry period will be displayed (the default is 24 hours).

The maximum value you can enter is 10584, though the real limit will depend on your Message Service Centre.

Outgoing Message Type

This option is network dependent and can be used to specify the format of your outgoing messages. You can select from the following message types: Text (default), Fax, X400, Paging, E-Mail, ERMES or Voice.

You do not need to select Voice to send messages to Voicemail boxes.



Phone Setup Menu

Phone Setup

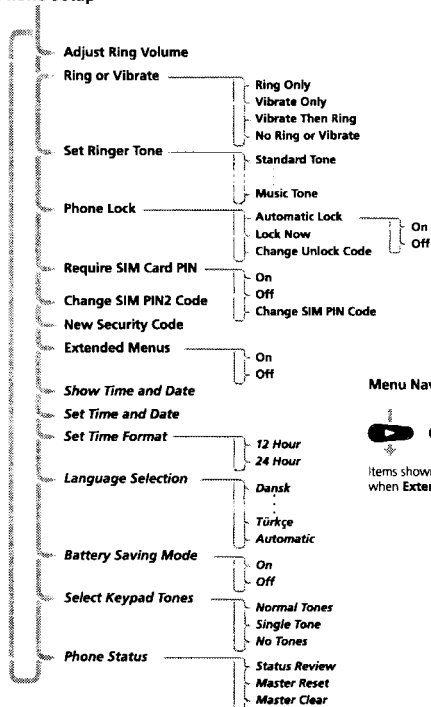

Menu Navigation



Items shown in *italics* are available only when **Extended Menus** are switched on.

Adjust Ring Volume

This option is used to set the incoming call ring tone volume. When selected, the phone rings, and the volume meter will be displayed as follows:

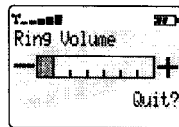

After selecting this menu item, adjust the volume by pressing the volume keys on the side of your phone.

The meter disappears after a short time, or by pressing **OK** or **C**.

Ring or Vibrate

This option sets the way your phone alerts you to an incoming call. The options are:

- *Ring Only* - the phone will ring with the tone specified by the Set Ringer Tone option.
- *Vibrate Only* - the phone will vibrate using VibraCall™.
- *Vibrate Then Ring* - the phone will vibrate twice and then ring.
- *No Ring or Vibrate* - the phone will just display the Call message.

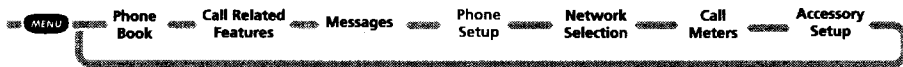

☞ The setting you choose also defines the type of alert for an incoming SMS message (except that if you select *Vibrate Then Ring*, your phone will just vibrate).

OK Set Ringer Tone

This option sets the tone your phone will make when an incoming call is received.

Standard Tone

Your phone makes a standard ringing tone.

Single Ring Tone - Music Tone

When selected, your phone will produce one of these alternative ringing tones.

☞ If you select the *Single Ring Tone* option, the phone will only ring once when a call is received.

OK Phone Lock

This option is used to set, and change, the unlock code.

The unlock code can be set to protect your phone from unauthorised use. It can be set to automatically lock your phone each time it is switched on.

The unlock code is a four digit number which is set at manufacture to **1234**. This can be changed at any time by using the 'change unlock code' option.

Automatic Lock

This option can be used to automatically lock your phone each time it is switched on.

The option has two settings, **On** or **Off**.

Lock Now

This option can be used to immediately lock your phone. Once selected, your phone will be unusable until the unlock code is entered.

Change Unlock Code

This option is used to change the unlock code.

After selecting this option, you will be asked to enter the current security code before you can proceed.

You can now enter a four digit code to replace the old code.

☞ By pressing **MENU**, you can access this option even when the phone is locked.

Require SIM Card PIN

This option is used to set, and change, the PIN code.

The PIN code can be set to protect your SIM card from unauthorised use. If set to **On**, access to your SIM card will be restricted each time it is inserted or the phone is turned on.

The option has two settings, **On** or **Off**.

☞ If the SIM card does not support PIN code disabling, these items will not appear.

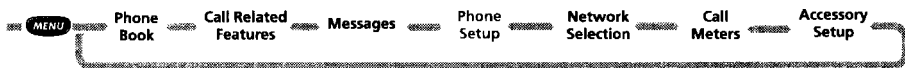

Change SIM PIN Code

This option is used to change the SIM card PIN code.

The 'Require SIM Card PIN' option must be set to **On** and you must enter the old PIN code before you can proceed.

You will be asked to enter a new, four to eight digit code to replace the old PIN code. The new PIN code must be entered again as confirmation.

! If the PIN number is entered incorrectly three times in a row, your SIM card will automatically lock-up and the **Blocked** message will be displayed.

Unblocking Your Phone

If you receive the **Blocked** message you will need to enter an unblock code and key sequence before you can use the phone.

! The 8 digit PIN unblocking code will have been provided with your SIM card by your Cellular Service Provider.

Enter the following key sequence to unblock your phone:

*** * 0 * 5 * * Unblock Code OK**

New PIN Code OK New PIN Code OK

The new PIN code must contain four to eight digits.

! If this operation is performed incorrectly 10 times in a row, your SIM card will become permanently blocked.

Change SIM PIN2 Code

This option is used to change your PIN2 security code.

When you select this option you must enter the old PIN2 security code before you can proceed.

You will be asked to enter a new, four to eight digit code to replace the old PIN2 security code. The new PIN2 security code must be entered again as confirmation.

! If the PIN2 security code is entered incorrectly three times in a row, the **Blocked** message will be displayed.

When the **Blocked** message is displayed, you are not allowed access to menu items that require you to enter the PIN2 code, for example 'Setup Fixed Dialling' and 'Call Charge Settings'.

If you receive the **Blocked** message when you try to enter your PIN2 code, you will need to unblock and change the code using the following key sequence:

*** * 0 * 5 * * 2 * * Unblock Code OK**

New PIN2 Code OK New PIN2 Code OK

! The 8-digit unblocking code will have been provided with your SIM card by your Cellular Service Provider.

! If the PIN2 unblocking operation is performed incorrectly 10 times in a row, your PIN2 code will become permanently blocked.

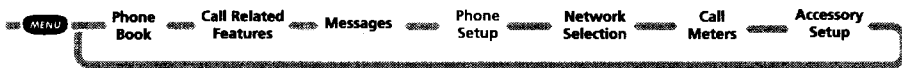

- ☞ *The setting you choose also defines the type of alert for an incoming SMS message (except that if you select Vibrate Then Ring, your phone will just vibrate).*

OK Set Ringer Tone

This option sets the tone your phone will make when an incoming call is received.

Standard Tone

Your phone makes a standard ringing tone.

Single Ring Tone - Music Tone

When selected, your phone will produce one of these alternative ringer tones.

- ☞ *If you select the Single Ring Tone option, the phone will only ring once when a call is received.*

OK Phone Lock

This option is used to set, and change, the unlock code.

The unlock code can be set to protect your phone from unauthorised use. It can be set to automatically lock your phone each time it is switched on.

The unlock code is a four digit number which is set at manufacture to **1234**. This can be changed at any time by using the 'change unlock code' option.

Automatic Lock

This option can be used to automatically lock your phone each time it is switched on.

The option has two settings, On or Off.

Lock Now

This option can be used to immediately lock your phone. Once selected, your phone will be unusable until the unlock code is entered.

Change Unlock Code

This option is used to change the unlock code.

After selecting this option, you will be asked to enter the current security code before you can proceed.

You can now enter a four digit code to replace the old code.

- ☞ *By pressing **MENU**, you can access this option even when the phone is locked.*

Require SIM Card PIN

This option is used to set, and change, the PIN code.

The PIN code can be set to protect your SIM card from unauthorised use. If set to On, access to your SIM card will be restricted each time it is inserted or the phone is turned on.

The option has two settings, On or Off.

- ☞ *If the SIM card does not support PIN code disabling, these items will not appear.*

Phone Status

Status Review

This option can be used to view the current setting of menu options.

When selected, your phone will display the list of menu items that you have changed from the default setting.

Master Reset

 This option should be used with caution.

This option is used to restore certain phone options to their original settings.

When selected, you will be asked to enter the security code. Once entered, the master reset option will perform the following operations:

- Cancel Automatic Answer, Audible Call Timers, In-Call Display Meter, Battery Save (DTX), Auxiliary Alert, Automatic Handsfree, Automatic Lock, Cell Broadcast and Talk and Fax Mode.
- Return Language Selection to Original.
- Restore Keypad Tones to Normal, Ringer Tones to Standard, Volume Level to the middle of its range and Network Search frequency to Medium.
- Reset the expiry period for SMS messages to 24 hours and the Message Type to Text.
- Reset Quick Access functions to original default.

Master Clear

 This option should be used with extreme caution, for example it will clear all the Phone Book entries from your phone memory.

This option is used to restore certain phone options to their original settings.

When selected, you will be asked to enter the security code. Once entered, the master clear option will perform the same operations as 'Master Reset', plus the following operations:

- Clear the Phone Book entries from phone memory (not from SIM memory)
- Clear the Last Calls Made and Last Calls received list
- Clear the Message Editor.
- Reset the Resettable Call Timers.

Master Clear does **not** clear the:

- Fixed Dial list
- My Number(s) list
- Charge Meters
- Received and Outgoing Messages list.

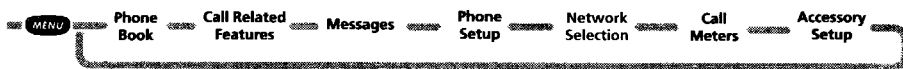

Network Selection Menu

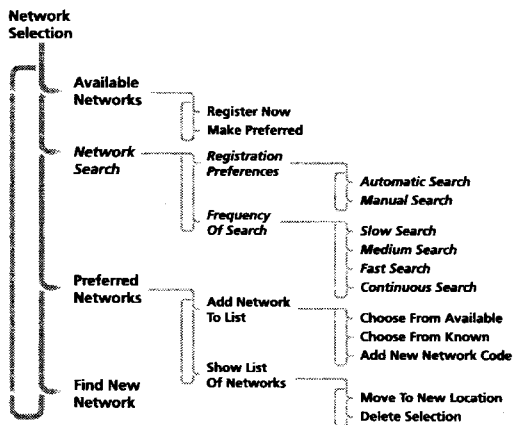

Menu Navigation



Items shown in *italics* are available only when **Extended Menus** are switched on.

Network Selection

In order for the phone to make and receive phone calls, it must register with one of the available networks.

Your phone automatically searches for the last network used. If, for any reason, this network is unavailable, your phone will attempt to register with a new network.

When your phone needs to register with a new network, it will generate a sorted list of networks. The network list is sorted in the following order:

- The Home network.
- Networks from a preferred list.
- A random list of other networks found above a certain signal strength.
- All remaining networks in descending order of signal strength. Any forbidden networks, stored in the SIM card, will not be included in the sorted list.

Available Networks

When selected, this option will scan to see which networks are operating in your current location. When you see a network you wish to register with or store in your preferred list, press **OK**. You will now enter the 'Register Now' and 'Make Preferred' sub-menu.

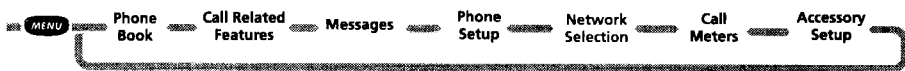

Register Now

Once selected, your phone will try to register with the selected network. If the registration fails, your phone will try to register in the normal way.

Make Preferred

Once selected, you will be asked where the selected network is to be located in the preferred list.

Network Search

These options determine how often your phone tries to register with a network and how the attempt is made.

Registration Preferences

This option determines how the phone tries to register with a network.

The option has two settings, Automatic Search or Manual Search.

Automatic Search Mode

In the automatic mode, the phone will try to register with the first network in the sorted list. If this is successful, your phone will display the network name and then enter the standby mode.

If registration is unsuccessful with one network in the list, your phone will try the next listed network. If your phone fails to register with any of the listed networks, it will start at the beginning of the list after a preset period. The preset period is determined by the 'Frequency Of Search' option.

Manual Search Mode

In the manual mode, the phone will present you with the sorted list of networks. Your phone will try to register with the selected network. If this is successful, the phone will display the network name and then enter the standby mode.

If registration is unsuccessful, your phone will present the list again after a preset period. The preset period is determined by the 'Frequency Of Search' option.

Frequency Of Search

This option is used to determine how long your phone waits before attempting to re-register after a registration attempt has failed.

The option has the following settings: Slow Search, Medium Search Fast Search or Continuous Search.

! *Fast and Continuous Search may use up a significant amount of battery power.*

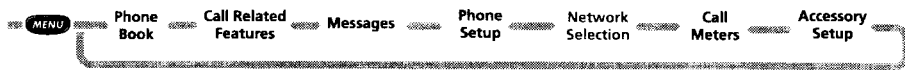

OK Preferred Networks

Add Network To List

This option enables you to add networks to your preferred list.

When selected, the 'Choose From Available' option will scan to see which networks are operating in your current location. When you see a network you wish to store in your preferred list, press **OK**. You will be asked where the selected network is to be located in the preferred list.

The 'Choose From Known' option will, when selected, present you with a preset list of networks. When you see a network you wish to store in your preferred list, press **OK**. You will be asked where the selected network is to be located in the preferred list.

Select the 'Add New Network Code' option to enter network codes directly. Once entered, you will be asked where the network is to be located in the preferred list.

Show List Of Networks

This option is used to display the networks you have stored in your preferred list. In addition, pressing **OK** will select the currently displayed entry and enter a move/delete sub-menu.

When 'Move to New Location' is selected you will be asked to enter a new location for the selected network.

When selected, 'Delete Selection' will remove the selected network from the preferred list.

Find New Network

When selected, the phone will try to register with a network in the normal manner, with one exception. When the registration attempt is made, your current network will be excluded from the list of those available. If the attempt fails, your phone will then try to re-register with the previous network.



Call Meters Menu

Call Meters

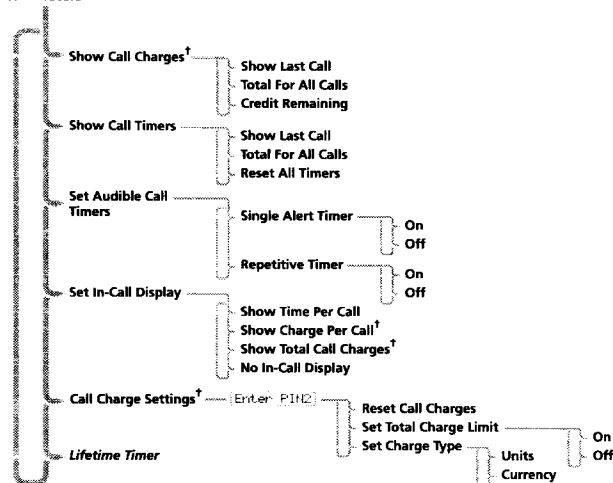

Menu Navigation



Items shown in *italics* are available only when **Extended Menus** are switched on.

† Availability depends on the type of SIM card.

Call Metering

Your phone has an internal metering system which can be used to provide you with individual and total call times or costs.

Call cost information is only available if you receive the Advice of Charge service. If you do not receive this service, then only time meters are available.

The meter can be displayed during a phone call and audible tones can be generated to indicate the passage of call time.

Your phone can handle values up to 21 digits long, although during calls it can only display the last 12 digits. If the value exceeds 21 digits, then **Too Large** is displayed.

In addition, you can set a maximum charge limit so that your phone will monitor either the number of units used or the call cost, and then not allow the limit to be exceeded.

Show Call Charges

This feature allows you to display the cost of your calls or the amount of credit remaining. The figures are in phone units or currency depending on the setting of the **Set Charge Type** option.

Show Call Charges is only available if you receive the Advice of Charge service.

Show Last Call

Displays the cost of your last chargeable call.

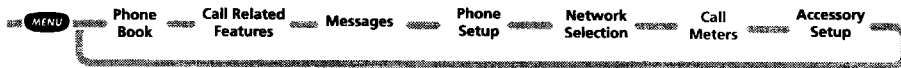

Total For All Calls

Displays the cost of all your chargeable calls since the charge meters were reset to zero using the 'Reset Call Charges' option.

Credit Remaining

Displays the difference between your total call costs and the limit specified by the 'Set Total Charge Limit' option. If there is no limit, No Charge Limit Set will be displayed.

Show Call Timers

This feature allows you to display the duration of your calls and to reset your time meters to zero.

If you receive the Advice of Charge service then all calls are timed. If you do not receive the Advice of Charge service then, depending on the model, either all calls or only outgoing calls are timed.

Show Last Call

Displays the duration of your last call.

Total For All Calls

Displays the duration of all your calls since the time meter was reset to zero using the 'Reset All Timers' option.

Reset All Timers

Sets the resettable time meters to zero. The Lifetime Meter is not resettable.

OK Set Audible Call Timers

Your phone provides two programmable audible call timers:

- The 'Single Alert Timer' will sound a beep just once during a call, after a preset time has elapsed.
- The 'Repetitive Timer' will sound regular beeps during a call, at preset intervals.

In both cases, the timers will sound their beeps ten seconds before the end of the programmed time.

Set In-Call Display

This feature allows you to specify whether the time or charge meters are displayed during a call. If you do not have the Advice of Charge service, then only the time meter is available.

 *If a total charge limit has been set, then the in-call display always shows your remaining credit.*

Show Time Per Call

This option is used to display the time meter during calls. If you receive the Advice of Charge service, only the chargeable calls will be displayed.

Show Charge Per Call, Show Total Call Charges

 *These menu items are only available if you receive the Advice of Charge service.*

These options are used to display the call charges meter during and after chargeable calls. The meter shows phone units or currency depending on the setting of the 'Set Charge Type' option.



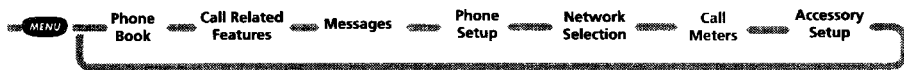

No In-Call Display

This option switches off in-call display of the charge/time meter.

Call Charge Settings

This feature allows you to customise your Advice of Charge settings. You will be prompted to enter your PIN2 security code before you can access the options.

 *This menu item is only available if you receive the Advice of Charge service.*

Reset Call Charges

This option resets your charge meters to zero.

Set Total Charge Limit

This option sets the maximum limit for call charges; once this limit has been reached, the network will refuse any further chargeable calls.

If you switch the charge limit **On**, you will be prompted to enter a new limit. Enter the amount as either units or currency depending on the setting of the **Set Charge Type** option. Units must be entered as whole numbers.

 *When the charge limit is **On**, you will not be able to make fax or data calls.*

Once a limit is set, the in-call display will show the remaining credit. When you reach your last two minutes, the warning message **Approaching Charge Limit** will be displayed and a warning alert will sound. The sound will be repeated when one minute remains. When the limit is reached the message **Charge Limit Reached** will be displayed and you will not be able to make any more chargeable calls.

Once the limit is reached the Total Charge Limit will need to be reset or switched off before any chargeable calls can be made.

Select **Off** to switch off the charge limit.

Set Charge Type

This option defines whether charge information is displayed as either phone units or currency.

Units

Sets the charge type to phone units.

Currency

Sets the charge type to currency. You will be prompted to enter the **Currency Name**. Enter a 3-character notation, for example **GBP** for the UK, **DEM** for Germany or **FFR** for France. You will then be prompted for the **Charge Per Unit**. Enter the amount and press .

Lifetime Timer

This option is used to display the total time of all calls made on your phone.

This meter can not be reset, the 'Reset All Timers', 'Master Reset' or 'Master Clear' options have no effect.

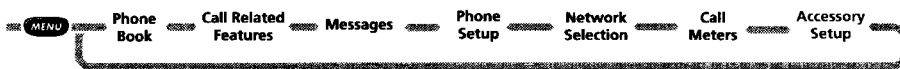

Accessory Setup Menu

Accessory Setup

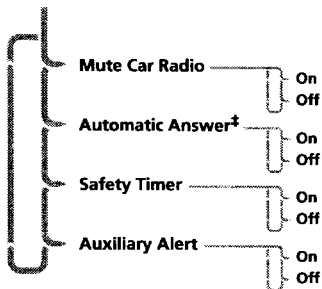

Menu Navigation



‡ Availability depends on the type of car kit installed.
You will only be able to access this menu when your phone is mounted in a car kit.

Car kits can provide charging facilities and some provide connection to an external antenna for better reception. Your phone can also be linked to external microphones and speakers for hands free operation.

Your phone provides several options to complement the use of car kits.

OK Mute Car Radio

Mutes your car radio when you make, or receive a call, when your phone is attached to the car kit. It must be enabled by your local dealer.

 This option will have no effect if your car radio does not have a mute feature, or if the car kit installation does not support this option.

Automatic Answer

Allows your phone to automatically answer an incoming call after two rings.

 If this option is On, we recommend that the 'Ring or Vibrate' option be set to Ring Only.



Safety Timer

Used to leave the phone on for a set period after the vehicle ignition has been turned off. This prevents the vehicle's battery from becoming drained and saves you from having to re-enter PIN and Unlock codes after every short stop.

As standard the 'Safety Timer' is set to 60 minutes. Once selected, this option can be adjusted to any value between zero and 999 minutes. When set to zero, this option is effectively switched off.

Auxiliary Alert

Alerts you of an incoming call by flashing your vehicle lights, or by sounding the horn. It must be enabled at the time of installation.



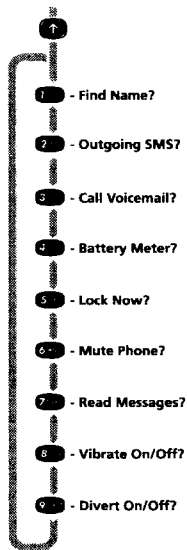

 *Some local regulations prevent the use of this option and, accordingly, this option may not be present on your phone.*

Using the Quick Access Menu



 The menu shown above represents the default features supplied with your phone.



Although the features in your phone are available through easy access menus, some of the most commonly used features are also available in the Quick Access menu. Each feature in the menu is allocated a number from 1 to 9.

To use a Quick Access feature, press the quick access key () followed by the number of the feature, or press  or  to scroll through the menu and then press .

You can change the features, and the positions of the features, available in the Quick Access menu - see 'Customising the Quick Access Menu'.

Each Quick Access feature is represented by an icon as well as the feature name. The currently selected icon is shown with a dark background.

Find Name?

Enter the first three characters of the name and press . The first matching entry in the Phone Book will be displayed. Press  to call the number.

Outgoing SMS?

Your newest message will be displayed; you can then read, send, delete and edit messages as normal. See 'Outgoing Messages' for more information.

Call Voicemail?

Your phone will make a call to your voicemail number.

 You must have defined a Voicemail number in order to use this feature.

See 'Call Voicemail' for more information.



Battery Meter?

A bar graph indicating the approximate battery charge level will be displayed. The more bars displayed, the greater the charge level.

See 'Show Battery Meter' for more information.

Lock Now?

Prompts you to confirm that you want to lock the phone. If this is given, your phone becomes locked and you will not be able to use it again until the unlock code is entered.

See 'OPhone Lock' for more information.

Mute Phone?

Temporarily turns the microphone off during a phone call. Reselect this option to resume your conversation.

Read Messages?

Your newest message will be displayed; you can then read, delete and edit messages as normal. See 'Received Messages' for more information.

Vibrate On/Off?

VibraCall™ will be switched either on or off depending on the current setting. If VibraCall™ is switched on, the 'Ring or Vibrate' setting changes to **Vibrate Only**. If VibraCall is switched off, the 'Ring or Vibrate' setting changes to **Ring Only**. See 'Ring or Vibrate' for more information.

Divert On/Off?



Unconditional call diversion will be switched either on or off depending on the current setting.

 You must have defined a diversion number using the 'Divert All Calls' option in the Call Diverting menu in order to use this feature.

You cannot switch call diverting on or off if you are outside GSM coverage.

*The remaining quick access options are not included in the default menu supplied with your phone. Refer to **Customising the Quick Access Menu** for information on how to create your own menu.*

Find Location?

Enter the location number and press . The first matching entry in the Phone Book will be displayed. Press  to call the number.

Add to Phone?

Enter a phone number and then a name.

 If you already had a number displayed, it will automatically be re-displayed when you select this feature.

The number will be stored in the next available phone memory location. See 'Add Entry' for more information.

Add to SIM?

Enter a phone number and then a name.

 *If you already had a number displayed, it will automatically be re-displayed when you select this feature.*

The number will be stored in the next available SIM card location. See 'Add Entry' for more information.

Adjust Ring?

Displays and sets the incoming call ring-tone volume. Press the quick access key, then set the volume with the volume up/down buttons.

Switch Memory?

Switches one-touch dialling between the phone and SIM memories depending on the current setting.

Message Editor?

The last message edited will be displayed. Press and hold  to clear the message and start a new one, or modify the message displayed. See 'How to Create and Edit SMS Messages' for more information.

Received Calls?

Displays the first entry in the Last Calls Received list. You can scroll through the list and call the numbers as normal. See 'Last Calls Received' for more information.

Call Charge?

Displays the cost of your last chargeable call. See 'Show Call Charges' for more information.

Call Timer?

Displays the duration of your last chargeable call. See 'Show Call Timers' for more information.

Talk and Fax?

Switches Talk and Fax on for the next call only. See 'Talk and Fax' for more information.

Show My ID?

Your phone number will be sent with the next attempted call; after this your phone number will not be sent until you reselect this option.

Restrict My ID?



Your phone number will not be sent with the next attempted call; after this your phone number will be sent until you reselect this option.



Customising the Quick Access Menu

You can change the features in the Quick Access menu to suit your personal preferences.

To customise the menu:

- 1 Press  and scroll to the menu item you wish to change.
- 2 Press and hold  to access the list of features available. The currently selected feature will be displayed.
- 3 Scroll through the list until you find the feature you wish to store in the Quick Access menu; press .
- 4 **Completed** will be displayed to confirm that the feature has been stored.

The items in the Quick Access list will appear in the following order:

- 
- Find by Name
 - Find by Location
 - Add Entry to Phone
 - Add Entry to SIM
 - Call Voicemail
 - Battery Meter
 - Phone Lock Now
 - Phone Mute On or Off
 - Ring Volume
 - VibraCall On or Off
 - Divert All On or Off
 - Switch Memory

- Read Messages
- Outgoing Messages
- Message Editor
- Last Calls Received
- Last Call Charge
- Last Call Timer
- Talk and Fax
- Show My ID Next Call
- Restrict My ID

The following accessories have been designed to work with your phone. Additional accessories may be available and are packaged separately. Please refer to your local service provider or retail outlet for more information.

Desktop Charger (SPN4325)

The Desktop Charger allows you to charge a phone with a battery attached and a spare battery at the same time. The charging status for each battery is indicated by LEDs at the front of the charger.

 *The Desktop Charger must be used with the power adapter (SPN4278).*

Travel Charger (SPN4278)

The power adapter (charger) connects to the Desktop Charger or directly to the phone. When connected directly to the phone, it charges the battery and also provides dead battery operation.

Cigarette Lighter Adapter (SYN4241)

The Cigarette Lighter Adapter connects to your phone and allows you to charge your phone's battery while driving. When the phone is in use, the adapter overrides the battery therefore preserving battery life. The adapter also provides dead battery operation.

The Cigarette Lighter Adapter is also available with a connection to an external antenna (SLN9934).

Handsfree Car Kit (S6649)

The Handsfree Car Kit allows you to safely operate your phone while driving. The car kit provides a responsive directional microphone and direct antenna connection. While connected to the phone, the car kit also charges the battery.

UK Adapter Plug (SYN4656)

The UK Adapter Plug connects the Power Adapter to a UK-style mains power outlet.

European Adapter Plug (SYN4655)

The European Adapter Plug connects the Power Adapter to a Continental European-style mains power outlet.

US Adapter Plug (SYN4657)

The US Adapter Plug connects the power adapter to a USA-style mains power outlet.



Batteries

	Type	Capacity	Part Number
Main batteries	Slim Li-ion	500mAh	SNN4937
	Extra capacity Li-ion	900mAh	SNN4936
Auxiliary batteries	Li-ion	900mAh	SNN4867



You can't switch your phone on	<p><i>Check the battery.</i> Is it charged, properly fitted and are the contacts clean and dry? See 'Important Battery Information'.</p>
You can't make calls	<p><i>Check the antenna.</i> Is it fully extended?</p> <p><i>Check the signal strength meter in the display.</i> If the signal is weak, move to an open space or, if you are in a building, move closer to a window.</p> <p><i>Check the Network Selection settings.</i> Try Manual Selection, or try another network. See 'Network Search'.</p> <p><i>Check your Operator coverage map.</i></p> <p><i>Is Restricted displayed?</i> Check the Call Barring and Fixed Dialling settings.</p> <p><i>Has the call charge limit been reached?</i> Use your PIN2 code to reset the limit or contact your Service Provider. See 'Set Total Charge Limit'.</p> <p><i>Has a new SIM card been inserted?</i> Check that no new restrictions have been imposed.</p>
You can't receive calls	<p><i>Check the antenna.</i> Is it fully extended?</p> <p><i>Check the signal strength meter in the display.</i> If the signal is weak, move to an open space or, if you are in a building, move closer to a window.</p> <p><i>Check the Call Diversion and Call Barring settings.</i></p> <p><i>Check the Ringer and VibraCall settings.</i> If both are off, there is no audible alert. See 'Ring or Vibrate'.</p>
Your phone won't unlock	<p><i>Have you inserted a new SIM card?</i> Enter the new PIN code. See 'Entering Your SIM Card PIN Code'.</p> <p><i>Do you have a replacement phone?</i> Enter the default phone unlock code - 1234.</p> <p><i>Have you forgotten the unlock code?</i> Press MENU to change the unlock code (you will need your security code).</p>
Your PIN is blocked	<p><i>Enter the PIN unblocking code supplied with your SIM card (see 'Unlocking Your Phone').</i></p>
Your PIN2 is blocked	<p><i>Enter the PIN2 unblocking code supplied with your SIM card (see 'Change SIM PIN2 Code').</i></p>



Your SIM card won't work	<p><i>Is the card inserted the right way round? See 'SIM Card Insertion'.</i></p> <p><i>Is the gold chip visibly damaged or scratched? Return the card to your Service Provider.</i></p> <p><i>Check the SIM contacts. If they are dirty, clean them with an antistatic cloth.</i></p>
The battery won't charge	<p><i>Check the charger. Is it properly connected? Are its contacts clean and dry? See 'Your Battery'.</i></p> <p><i>Check the battery contacts. Are they clean and dry?</i></p> <p><i>Check the battery temperature. If it is warm, let it cool before recharging.</i></p> <p><i>Is it an old battery? Battery performance will decline after several years use. Replace the battery.</i></p>
The battery drains faster than normal	<p><i>Are you in an area of variable coverage? This uses extra battery power.</i></p> <p><i>Is your antenna fully extended? This helps use less battery power.</i></p> <p><i>Is it a new battery? See 'Charging a New Battery'</i></p> <p><i>Is it an old battery? Battery performance will decline after several years use. Replace the battery.</i></p> <p><i>Is it a battery that hasn't been completely discharged? Allow the battery to fully discharge (until the phone turns itself off) and then charge the battery overnight.</i></p> <p><i>Check that the Frequency Of Search feature in the Network Selection menu has not been set to Fast or Continuous. See 'Network Search'.</i></p> <p><i>Check that the Battery Saving Mode feature has not been set to Off.</i></p> <p><i>Are you using your phone in extreme temperatures? At extreme hot or cold temperatures, battery performance is significantly reduced.</i></p>
You can't cancel Call Diverting or Call Barring	<p><i>Wait until you are in an area with good network coverage and try again.</i></p>
The 0 symbol is flashing	<p><i>There is not enough memory available to store another SMS message. Use the Messages menu to delete one or more existing messages.</i></p>
I can't make international calls	<p><i>Some Service Providers automatically bar the ability to make international calls. Contact your Service Provider.</i></p> <p><i>Have you included the relevant codes? Press and hold 0 to display the international dialling prefix (+) and then enter the appropriate country code followed by the phone number.</i></p>



A

Accessories	63
Accessory setup menu	57
Add entry	
To phone memory	32, 60
To SIM card memory	32, 61
Adjust ring volume	46
Automatic answer	57
Automatic lock	47
Automatic redial	18
Auxiliary alert	58
Auxiliary battery	14
Available networks	51

B

Bar incoming calls	41
Bar outgoing calls	40
Batteries	
Auxiliary	14
Charging	11
Desktop charging	13
Fitting	14
Low battery warning	13
Maintaining	12
Removing	15
Battery charge indicator	10
Battery meter	36, 61
Battery saving mode	49
Blocked message	17, 48
Buttons	
SIM card release	10
Volume	9

C

Call barring	40
Call charge settings	56
Call diverting	37, 60
Call holding	39
Call metering	54
Call meters menu	54
Call related features menu	36
Call timers	55
Call voicemail	43, 61
Call waiting	39
Calling a number	18
Calling an embedded number	44
Cancel all diverting	38, 60
Capacity	
Checking battery capacity	36
Checking Phone Book capacity	32
Cell broadcast	45
Messages	43
Change bar password	41
Change SIM PIN2 code	48
Change unlock code	47
Characters	29
Charge meters	
Resetting	56
Check capacity (of the Phone Book)	32



D

Data calls	
Accessories	63
Diverting	38
Delete	
Last ten calls	33
Message	44, 45
Phone book entries	32
Desktop charging of your battery	13
Detailed diverting	38
Dialling phone book numbers	19
Display	10
Display characters	29
Displaying your own phone number	33
Divert	
All calls	37
Cancelling	38
Data calls	38
Fax calls	38
Voice calls	38
When unavailable	37
DTX	49

E

Editing messages	43
Emergency calls	20
Ending a phone call	21
Entering characters	29
Erase name and number	32
Extended menus	49

F

Fault finding	65
Fax calls	
Accessories	63
Diverting	38
Find entry by location	31, 60
Find entry by name	31, 59
Find new network	53
Fitting your battery	14
Fixed dialling	34
Calling numbers	34

I

In use symbol	10
International phone calls	19

K

Keypad tones	
Selecting	49

L

Language selection	49
Last ten calls	33, 61
Lifetime timer	56
Lock now	47, 60
Low battery warning	13



M

Making a phone call	18
Master clear	50
Master reset	50
Menu navigation	23
Menus	
Accessory setup menu	57
Call meters menu	54
Call related features menu	36
Extended menu	25
Messages menu	42
Network selection menu	51
Options menu	27
Personalised menus	25
Phone book menu	30
Phone setup menu	46
Quick Access menu	59
Short menu	25
Message editor	45, 61
Message settings	45
Messages	42
Call holding/call waiting messages	40
Calling an embedded number	44
Cell broadcast messages	43
Creating and editing	43
Reading SMS messages	43
Sending SMS messages	44
Messages menu	42
Mute car radio	57
My phone number(s)	33

N

Names	
Entering	29
Network search	52
Network selection menu	51
Networks	
Automatic search	52
Finding new networks	53
Manual search	52
New security code	49
O	
One-touch dial setting	35
One-touch dialling	19, 61
Options menu	27
Outgoing messages	44, 59

P

Pauses	
Inserting into phone numbers	19
Personal numbers	31
Personalised menu	25
Phone book	
Call number	32
Capacity	28
Deleting/erasing entries	32
Dialling phone book numbers	19
Modify name or number	32
Preventing access to	33
Storing numbers - <i>see Add Entry</i>	32
Phone Book entry key	9
Phone Book lookup key	9
Phone book menu	30
Phone calls	
Automatic redial	18
Dialling phone book numbers	19
Emergency calls	20
Ending	21
International	19
Making	18
One-touch dialling	19
Receiving	21
Phone setup menu	46
Phone status	50
PIN code	17, 22
Entering	17
Setting and changing	47
PIN2 code	22, 48
Postscripting	28



Preferred networks	53
Prevent access (to Phone Book)	33

Q

Quick access menu	59
Customising	62

R

Reading SMS messages	43
Received messages	44
Receiving a phone call	21
Removing your battery	15
Require SIM card PIN	47
Restrict my phone number	36, 61
Return call	44
Ring or vibrate	46
Ring tones	47
Roam symbol	10

S

Safety timer	58
Security code	22
Changing	49
Security features	22
Select keypad tones	49
Sending SMS messages	44
Service centre	45
Set audible call timers	55
Set in-call display	55
Set ringer tone	47
Setup fixed dialling	34
Short menu	25
Short message service symbol	10
Short Message Services (SMS)	42
Show battery meter	36, 61
Show call charges	54, 61
Show call timers	55, 61
Signal strength symbol	10
SIM card	
Insertion	16
PIN code	17, 22, 47
PIN2 code	22, 48
Release button	10
Removal	16
SIM Card PIN Code	17
SMS messages	42
Special keys	9
Status review	50
Symbols	10

T

Talk and fax	38, 61
Timers	55
Tones	
Selecting keypad tones	49
Setting ringer tones	47
Transmission rate	38
Troubleshooting	65

U

Unlock code	22
Unlocking your phone	48
Unconditional call diversion	37, 60
Unlock code	22
Entering	17
Setting and changing	47

V

VibraCall	46, 61
Vicemail	
Calling	43
Number	45
Volume	
Adjusting the ringer volume	46
Buttons	9

W

What to do if...	65
------------------------	----



