

fisio

625

PHILIPS

Discover your phone

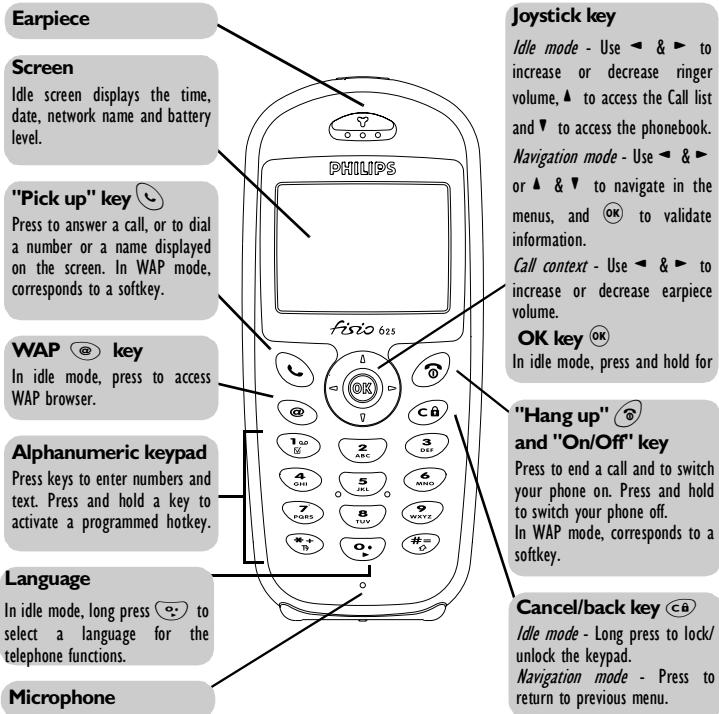

Philips continuously strives to improve its products, and the information and specifications described in this user guide are subject to change without notice. Philips tries to ensure that all information in this user guide is correct, but does not accept liability for any error, omission or discrepancy between this user guide and the product described.

Table of contents

Operate your phone	4	Voice dial.....	17
The carousel.....	4	Clear the call list.....	18
Text or number entry	4	Clear the SMS list.....	18
<i>T9® text Input</i>	4	Clear the phonebook.....	18
<i>Basic text input</i>	6	Lock / unlock the keypad	18
Reminder	7	Deactivate the ringer	19
1. Getting started.....	8	Activate the vibra alert	19
First steps.....	8	Read your mobile	
Get started.....	8	phone number.....	20
<i>Insert the SIM card</i>	8	During a call, you can... ..	20
<i>Enter the PIN code</i>	9	<i>Adjust the earpiece volume</i>	20
<i>Set date and time</i>	9	<i>Mute the microphone</i>	20
Copy of the SIM phonebook.....	9	<i>Unmute the microphone</i>	20
<i>Accept the copy</i>	9	<i>Write in the notepad</i>	20
<i>Refuse the copy</i>	10	<i>Consult the phonebook</i>	20
<i>Abort the copy</i>	10	<i>Record a conversation</i>	20
First call.....	10	<i>Other features during a call</i>	21
Customise your phone.....	10	3. Menu tree.....	22
Charge the battery.....	12	4. Display & images	24
2. Main features	14	Introduction.....	24
Idle screen	14	Images album.....	24
<i>Symbols</i>	14	Display	25
<i>Events</i>	15	<i>Screen saver</i>	25
Make a call.....	15	<i>Screen animation</i>	26
Answer and end a call.....	15	<i>Animation</i>	26
See & hear who's calling:		<i>Backlight</i>	26
Fotocall.....	16	5. Settings	
Redial and reply.....	16	& Quick Settings	27
Flash dial.....	17	Introduction.....	27

Settings	27	Read SMS	49
Sounds	27	Clear SMS	50
Display	29	SMS settings	50
Security	29	Broadcast SMS	51
Time and date	31	Call list	52
Language	32	Display	52
Accessories	32	Reset	52
Hotkeys	33	8. Organiser & Extras.....53	
Voice command	35	Introduction	53
Network	35	Organiser	53
Call settings	36	Creating a new event	53
Quick settings.....	38	Modifying an event	54
Quick settings	38	Views of events	55
Accessories settings	39	Time zone	56
6. Phonebooks40		Extras	56
Introduction	40	Brick game	56
Phonebook	41	Call counters	56
Phonebook in SIM card	41	Euro	58
Phonebook in phone	41	Memory status	58
Add names in the phonebook.....	41	Calculator	58
In the SIM card	41	Alarm clock	59
In the phone	42	Memo	59
Own number	43	9. E-mail60	
Edit and manage names	43	Introduction	60
In the SIM card	43	Settings	61
In the phone	43	Network access	61
7. Calls and messages46		E-mail server access	63
Introduction	46	Advanced	64
Call a number	46	Write and send e-mails.....	65
Emergency number	46	To one or several recipients	65
Other number	47	With an attachment	66
Messages	48	Receive and read e-mails.....	66
Send a SMS	48	Connect to the server	66

Download e-mails	67	Query a voice server, voice mailbox, messaging service, etc. (DTMF tones)	76
Get and store attachments	67	Pause and wait characters	76
Add an e-mail address to the phonebook	68	Access your answering machine (example)	76
Delete e-mails	69	Make a second call	76
Reply to an e-mail	69	Answer a second call	77
Forward an e-mail	69	Answer a third call (Subscription dependent)	78
10. WAP services.....	70	Conference Call	78
Introduction	70	Explicit Call Transfer	78
WAP	70	In-call symbols	79
Launch	70	Precautions	80
Browse	71	Troubleshooting	84
Favourites	71	Glossary	86
Last page	72	Philips authentic accessories	88
Advanced	72	Declaration of conformity	90
Access settings	72		
11. Other operator services	75		
Introduction	75		
GSM strings.....	75		

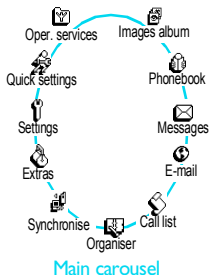

Operate your phone

The carousel



A carousel is a circular loop of icons displayed on the screen, in which each icon represents a feature or option used to operate your phone.



 All icons don't fit within the screen; the hidden ones appear when scrolling ◀ or ▶.

The first carousel available when you turn on your mobile phone is called the "main" carousel. You access it by pressing  when in idle mode, and it features the icons shown opposite. A small icon in the upper left corner of the screen shows your actual position within the carousel. To access a feature or option, move ◀ (anti clockwise) or ▶ (clockwise) and press  when the feature or option of your choice is selected. Another sub-carousel or list will then appear.

 Pressing ◀ or ▶ will alternate between two options, such as Activate/Deactivate, On/Off, Increase/Decrease a value, etc.

Repeat the operation described above and browse carousels and lists until you reach the desired feature or option. When navigating in a list, a scroll bar located on the right handside of the screen shows your actual position in the list. With the navigation key, you can then select or adjust all the functions of your phone as described in the relevant chapter of this user guide.

Text or number entry

Text can be entered in editing screens in two different ways: by using T9[®] predictive Text Input, or basic text input. Two other modes for numbers and punctuation marks, are also available. Icons appearing on the screen show the active text mode. You switch from one mode to the other by pressing the  key, and from lower to upper case by pressing the  key.

T9[®] text Input

What is it?

T9[®] predictive Text Input is an intelligent editing mode for SMS and e-mail, including a comprehensive dictionary. It allows you to quickly enter text. Press



Tegic Euro. Pat.
App. 0842463

only once on the key corresponding to each letter needed to spell a word: keystrokes input are analysed and the word suggested by T9® is displayed in the bottom of the screen. If several words are available according to the keys used, press to browse the list and choose from those proposed by the T9® built-in dictionary (see example below).

How to use it?

Alphabets and symbols represented by each key are as follows:

to	To key in letters.	or	To confirm entry.
	Short press to clear one entry, long press to clear all text.		Short press to browse the list of candidate words, long press to browse back.
	To select the typing mode.		Shift.

Example: how to enter the word "home":

- 1 Press The screen displays the first word of a list: **Good**.
- 2 Press to scroll and select **Home**.
- 3 Press to confirm **Home**.

Good T9

Home T9

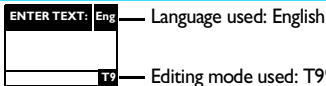

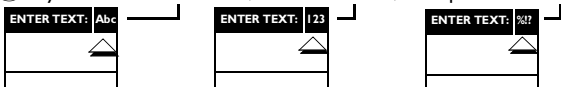

Press the key to switch to basic mode, to numeric mode, or to punctuation mode



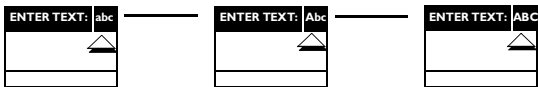









While in any text mode, press the key to switch from lower to upper case:















Basic text input

Although your phone provides you with the T9® predictive Text Input by default, if you wish to access the basic text input, select “Abc” basic text input using  key. This method requires multiple key presses to reach the desired character: the letter “h” is the second letter on key , you must press 2 times  in order to enter “h”. Using this mode requires you press a key as many times as is equal to the order of the letter.

























 *In basic mode, the complete list of characters available for the key you press appears in the bottom of the screen, allowing you to see each available character located on this key (see below).*

To enter the word “Home” in basic text input mode, you should therefore key in ,  (GHI) , ,  (MNO),  (MNO), ,  (DEF). Press  to confirm the completion of the editing.

Letters, numbers and symbols are located on each key as follows:

Key	Alphanumeric	Key	Alphanumeric
	space @ _ # = < > () & £ \$ ¥		t u v 8 ü ù
	a b c 2 à ä å æ ç		w x y z 9 ø Ω Ξ Ψ
	d e f 3 é è Æ Φ		. 0 , / ; ' ' ! ; ? ; * + - %
	g h i 4 Γ ì		Toggles between the different Text Input modes.
	j k l 5 Λ		Switches from lower case to upper case and vice-versa.
	m n o 6 ñ ò ö		Short press to delete one character, long press to delete all text.
	p q r s 7 β Π Θ Σ		

Reminder

Switch on/off	Press  to switch on, press and hold to switch off.
Enter PIN	Enter your PIN code using the keypad and press  or  to confirm.
Make a call	Enter phone number on keypad and press  to dial, or press  to select Call or Call handsfree , then press  or  to call.
Answer a call	Press  when your phone rings.
End a call	Press  .
View last call	Press  in idle mode.
Quickly access the Phonebook	In idle mode, move  .
Quickly access the Call list	In idle mode, move  .
Return to previous menu	Press  .
Return to idle screen	Press and hold  .
Lock/unlock the keypad	In idle mode, press and hold  .
Change the language used	In idle mode, press and hold  , select the language and press  .
Access the carousel	<ol style="list-style-type: none">1. Press  to access the Carousel.2. Move  or  to select a function, then press  to enter the sub-menu.3. Repeat step 2 until you reach the desired function.
Use the phonebook	<ol style="list-style-type: none">1. In idle mode, press .2. Browse the list by moving  or  and press  to call the selected name.

1 • Getting started

 Read the safety instructions in the "Precautions" section before use.

First steps

To use your phone, you must insert a valid SIM card supplied by your GSM operator or retailer. The SIM card contains your subscription, your mobile number, and a memory in which you can store phone numbers and messages (see "Phonebooks" page 40).

Get started

Insert the SIM card

- 1 Press on the two clips on each side of the back cover of your phone, as shown opposite (1). Rotate the cover from the bottom of the phone and remove it (2).

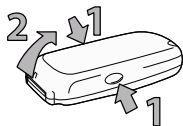

-  Make sure the phone is switched off before removing the cover.

- 2 Remove the SIM card from its holder and insert it in its slot, under the metal clip holder, until it stops. Be careful that the clipped corner of the card is in the bottom left corner as shown opposite.

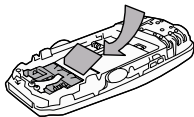

- 3 Slide the battery pack into its slots, metallic connectors downwards, until it stops.

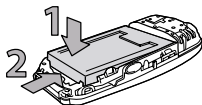

- Put the back cover back on your phone: hook the front housing onto the hinges on the top of the phone (1), then press the bottom down until latch catches (2).
- Remove the protective film before using the phone.

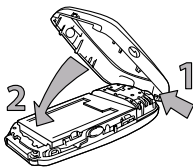

Enter the PIN code

- To switch on the phone, press and hold the **Ⓢ** key.
 - When you switch on the phone, you may be prompted to enter the PIN code, which is the 4 to 8-digit secret code of your SIM card to protect it from abusive use. It is preconfigured and communicated to you by your operator or retailer. To personalise the PIN code, see “Change codes” page 30.
- ⓘ** *If you enter a wrong PIN code 3 times, your SIM card is blocked. To unblock it, you must request the PUK code from your operator.*
- Enter your PIN code. If you make a mistake, press **Ⓢ**. Then confirm by pressing **OK** or **#**.

Set date and time

As prompted by the phone at first switch on, set the date by pressing the appropriate numeric keys (press **Ⓢ** to erase a number), then press **OK** to validate. Proceed in the same way to set the time.

ⓘ *For complete date and time options, see page 31.*

Copy of the SIM phonebook

ⓘ *If you do not copy the SIM phonebook at very first switch, you will be able to do it directly from the phonebook menu (see page 41).*

If you had a mobile phone before and are using the same SIM card, the card might contain all or part of your current phonebook. The mobile phone detects this and a message asks you if you want to copy your SIM phonebook onto the built-in phonebook (see below). Press **Ⓢ** to cancel or **OK** to accept.

Accept the copy

Press **OK** to accept the copy of the SIM phonebook onto your phone. Once the copy is done, the phonebook located on your phone is automatically set as

your default phonebook. To switch back to the SIM phonebook, select [Phonebook > In SIM card](#).

Refuse the copy

If you press the **(C&A)** key to refuse the download of your SIM card contents at switch on, the copy isn't launched and the phonebooks stay unchanged. The SIM phonebook is the default and you must select [Phonebook > Phonebook settings > Phonebook select > In phone](#) to switch phonebooks.

About the copy

- 1 If you change your mind while the copy has already taken place, press the **(C&A)** key to abort the download of your SIM card contents.
- 2 The copy is aborted and the phonebooks only contain the records downloaded before cancellation of the process.
- 3 The SIM phonebook is the default and you must select [Phonebook > Phonebook settings > Phonebook select > In phone](#) to switch phonebooks.

First call

- 1 Enter the phone number (if you make a mistake, press **(C&A)**) and press **(C)**.
- 2 Once connected, your phone emits 2 beeps. To end the call, press **(E)**.

Customise your phone

You can customise your mobile phone by removing front and back covers and replace them with different ones.

(B) *You must always remove the battery and make sure the phone is switched off before removing the cover when customising your phone.*

- 1 Press on the two clips on each side of the back cover of your phone, as shown opposite (1). Rotate the cover from the bottom of the phone and remove it (2).

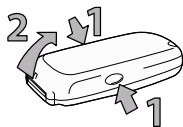

- 2 Remove the battery pack by sliding it downwards from its slot (1), then lifting it upwards (2).

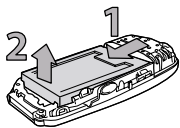

- 3 Then hold the phone upside down and place your forefinger on the connectors. Press the two inner clips with your left fingers as shown opposite (1) and pull the cover from the top while pushing the inside part of the phone with your forefinger still on the connectors (2).

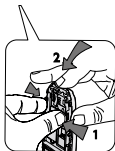
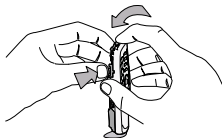

-  *Make sure you handle the product with care when the front is removed, in order not to damage the joystick key which is then unprotected, and also try not to touch the screen. Do not turn on your mobile phone when front and back covers are removed.*

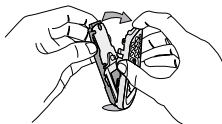

- 4 Remove the keypad and place it in the front cover that will replace the one you just removed.
- 5 Put the new front cover on your phone: hook the front housing onto the hinges on the top of the phone (1), then press the bottom down until the latches catch (2).

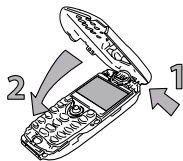

- 6 Slide the battery pack into its slots, connectors downwards, until it stops.

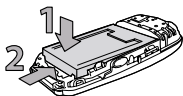

- 7 Put the back cover back on your phone: hook the front housing onto the hinges on the top of the phone (1), then press the bottom down until the latches catch (2).

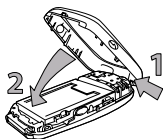



Charge the battery

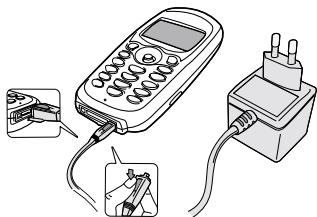

Your phone is powered by a rechargeable battery. A new battery is partially charged and an alarm will warn you when the battery reaches low.

 We recommend that you do not remove the battery when the phone is switched on: you may lose all your personal settings (see information on battery safety, page 82).

- 1 Once the battery and battery cover are clipped on the phone, plug the charger (supplied with the phone, in the box) into the right hand socket at the base of the phone as shown below.



- 2 Plug the transformer unit into a main AC power socket with easy access. The  symbol indicates the state of charge:
- During charging the 4 charge indicators change; Each bar represents around 25% of charge and it takes around 2.15 hours to fully recharge your mobile phone.



- **When all 4 bars are steady the battery is fully charged and you can disconnect the charger.**
 - When the battery is charged, remove the connector by pressing the release button on top of the connector.
 - Depending on the network and condition of use, talk time goes from 2.30 to 4.30 hours and standby time from 1 to 2 weeks.
-  *Keeping the charger plugged to the mobile when the battery is fully charged doesn't damage the battery. The only way to turn off the charger is to unplug it, so use an easily accessible AC power socket. You can connect the charger to an IT supply (Belgium only).*
- 3 If you don't intend to use your phone for several days, we recommend you to disconnect the battery.
-  *You can use the phone while it is on charge. If the battery is completely flat, the battery icon will only reappear after 2 or 3 minutes of charging.*

2 • Main features

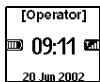





Idle screen



After switching your phone on and entering the PIN code (see page 8), your phone displays the idle screen which means that it is ready to be used. In idle mode, several symbols can be displayed simultaneously.

 If the  symbol isn't displayed, the network is not currently available. You may be in a bad reception area: move to a different location. The phone automatically returns to idle screen over 2 mn of inactivity.

Symbols

-  **Silent** - Your phone will not ring when receiving a call.
-  **Vibra** - Your phone will vibrate when receiving a call.
-  **Keypad lock** - Protects the keys from being pressed accidentally.
-  **SMS full** - Memory for messages is full. Delete old messages to receive new ones.
-  **Call Forward Unconditional to number** - All your incoming voice calls are being forwarded to a number other than voice mail.
-  **Call Forward Unconditional to voice mailbox** - All your incoming calls are being forwarded to voice mail.
-  **GPRS attach** - Your mobile phone is connected to the GPRS network.
-  **SMS message** - You have received a new message.
-  **Voice mail** - You have received a new voice mail.
-  **Battery** - The bars indicate the battery level (4 bars = full, 1 bar = low).
-  **Home zone** - A zone designated by your network operator. Subscription dependent, contact your service provider for details.
-  **GSM Network** : your phone is connected to a GSM network
-  **Reception quality** : the more bars are shown the better the reception is.
-  **Memo** - A memo or conversation has been recorded and saved but not yet played.
-  **Alarm clock** activated.
-  **Roaming** - Displayed when your phone is registered to a network other than your own (especially when you're abroad).

Events

Some events may modify the idle screen (missed call, new message, reminder from the organiser, etc.). In this case, press **OK** to access the corresponding menu or long press **C&A** to go back to idle.

H If you locked your keypad, you must unlock it before being able to access any menu. You lock/unlock your keypad by pressing and holding the **C&A** key.

Make a call

1 In idle mode, enter the phone number using the keypad. To correct an error, press **C&A**.

H For an international call, you can enter the "+" key instead of the usual international prefix. To do this press and hold **+** before dialling the country code.

2 Press **Call** to dial the number and press **End** to hang up.

H To learn other ways of making a call, see "Call a number" page 46.

Answer and end a call

1 When receiving a call, the phone can ring and/or vibrate, the incoming call animation and **Incoming call** are displayed. Depending on your subscription and if the caller has permitted this information to be transmitted, their number may be displayed. If the number is stored in the selected phonebook (see page 40), then the corresponding name is displayed instead of the number.

2 To answer the call, press **Call**.

3 To reject a call, press **End**. If you have activated "Call forward" (see page 36), the call is diverted to a number or voicemail.

H Notes:

- The phone will not ring if the ringer is deactivated (see page 19).
- If you have selected **Any Key Answer** (see page 38), you can accept a call by pressing any key (except **End**).

4 To hang up, press **End**.

See & hear who's calling: Fotocall

 This feature is only available when you select the phonebook of your phone, not the SIM phonebook.

The Fotocall feature allows you to:

- personalize the 10 groups available with a specific name ("Friends", "Office", "Leasure", etc.), a given picture of the **Picture album** and a melody of the **Ringer** list,
 - link one or several contacts of your phonebook to a group, so that when the/a person of this group calls you, his/her name appears on the screen together with the picture of the group he/she belongs to. The melody defined for this group will also ring.
- 1 If not done during the start-up procedure (see "First steps" page 8), copy the content of your SIM phonebook onto your phone: press **OK** and select **Phonebook**, **Phonebook settings**, **Copy all to phone** and press **OK**. Wait for the copy to be completed.
 - 2 Back to the **Phonebook** carousel, select **Group settings**, press **OK** and select the group of your choice.
 - 3 Rename the group to be identified ("Friends", "Kids", etc.) and select the **Melody** and the **Picture** to be associated to this group.
 - 4 Long press **CA** to go back to idle, then **▼** to display the content of your Phonebook. Select a contact you wish to link to this group and press **OK**. Then choose **Select group** and select the group of your choice.
 - 5 When this contact calls you, the **Melody** and **Picture** associated to his group will ring/appear on the screen.

Redial and reply

The phone stores the last 30 numbers in the **Call list** (called, missed or received). You can redial or reply to any of these numbers and dial it directly. The most recent number is displayed first.

- 1 In idle screen, move **▲** to access the **Call list**, which displays a chronological list of the last calls received or made. If a number of the Call list is also in your **Phonebook**, the corresponding name is displayed.
- 2 Move **▲** or **▼** to select the number to redial or reply. Press **☎** to dial the selected number and press **ⓞ** to hang up.

Flash dial



Flash dial

Instead of accessing the **Phonebook** menu and scrolling through the list, you can link the relevant name card to a hotkey, so that a long press on the chosen key will directly call him (e.g. long press on **2** to call your home or on **3** to call your office).

B You can only program keys **2** to **9**, as keys **0*** (selection of the language) and **1*** (voice mailbox) are predefined and cannot be changed.

- 1 To set a hotkey for flash dial, press **OK** to enter the main menu, then select **Settings** > **Hotkeys** and press **OK**.
- 2 Select a key "Not in use" from **2** to **9** and press **OK**.
- 3 Then select **Flash Dial**, press **OK** and select a name in the **Phonebook** displayed. Press **OK** to confirm your choice.
- 4 In idle mode, press and hold the programmed key to dial the associated entry: the connection is established. Press **Ⓣ** to hang up.

B You can also set hotkeys for commands (see "Hotkeys" page 33). Hotkeys can be changed or deleted at any time.

Voice dial



Voice Dial

Voice dial also allows you to quickly call a name from your phonebook: instead of programming a hotkey, you simply set a voice command by recording a word that will call the corresponding name when pronounced.

- 1 To set a voice tag for voice dial, press **▼** when in idle mode, select the name of your choice in the list and press **OK**.
- 2 Depending on the selected phonebook (see "Phonebooks" page 40):
 - SIM phonebook: press **OK**, select **Voice dial** and press **OK**,
 - phonebook in phone: select **Show** and press **OK**, then select the phone number of your choice if several numbers were stored for this name and press **OK**. Then select **Voice dial** in the carousel menu, and press **OK**.
- 3 When the option **Add voice tag?** appears, press **OK**, then follow the instructions displayed on the screen. When prompted to record your voice tag, make sure you are in a quiet environment, choose a short and simple word and clearly pronounce it.

- 4 From the **Voice dial** menu, long press to go back to idle.
- 5 Press and hold when in idle mode, then say the voice tag corresponding to the number you want to dial.

To display the list of voice dials you have defined, select **Settings**, **Voice Commands**, **Voice dial** and press . You can also set a voice tag for a voice dial from this menu, by selecting the **<New>** item, pressing and following the instructions appearing on the screen.

Voice tags you set for Voice dial can be played, changed or deleted at any time. You can also set a voice tag for a voice command (e.g. launch calculator or add organiser event, see page 35).

- The duration of a voice tag is 2 seconds. Up to 40 voice tags can be defined and shared between voice dial and voice command.*

Clear the call list



To clear your call list, press and select **Call list**, then **Reset**. Press to reset the call list.

Clear the SMS list



As explained further in this guide, short messages (SMS) sent or received can also be saved (see “Read SMS” page 49). To clear the whole list at once, press and select **Messages**, then press . Select **Reset** and press to reset the SMS list.

- Deleting your SMS list is useful to free memory space in order to receive new messages.*

Clear the phonebook





To clear the content of your phonebook at once, press and select **Phonebook**, **Phonebook settings**, **Reset phonebook**. Press to reset the phonebook content.

- This option only applies to the phonebook in your phone, not to the SIM phonebook (see “Phonebooks” page 40).*

Lock / unlock the keypad



You can lock the keypad to protect the keys from being pressed accidentally (e.g., when the phone is in your pocket).

To lock the keypad, press and hold  when in idle screen. The icon  appears on the screen. To unlock the keypad, press and hold  again.

 Notes:

- You can also choose immediate or delayed lock by selecting **Settings** > **Security** > **Keypad lock**, then one of the available values. In this case, your keypad will be permanently locked. If you unlock it by pressing the  key, it will be temporarily unlocked while you use your phone, and then locked again after the time period you selected.
- The emergency number is available even when the keypad is locked and you can still receive calls (see “Emergency number” page 46).
- Immediate keypad lock can be assigned to a Hotkey (see page 33).
- You must unlock your keypad before switching the phone off.
- It is possible to accept or reject a call even when the keypad is locked. The keypad is unlocked automatically when the phone receives a call, and then re-locks again once the call is finished.

Deactivate the ringer



Silence

If you don't want your phone to ring when you receive a call, you can deactivate the ringer. In this case, the incoming call symbol flashes when you receive a call, the display shows **Incoming call**, but the phone doesn't ring. To deactivate the ringer, proceed as follows:

- 1 Press  and select **Settings** > **Sounds** > **Ringer volume**.
- 2 Move  until the volume is set to **Silence**.





 *Silent mode can also be set by selecting **Quick Settings** > **Silence**. In this case, the vibra alert is also activated. For faster access, you can assign a hotkey to this function.*

Activate the vibra alert



Vibra alert

If you have set the function, your phone vibrates when receiving an incoming call (activating the silent mode via the **Silence** Quicksetting as described above will also activate the vibra alert). Otherwise, proceed as follows:

- 1 In idle screen, press  and select **Settings** > **Sounds** > **Vibra**.
- 2 Move  or  to select **On** or **Off** and press  to confirm.

-  Activating the vibra doesn't mute the ringer. If you want to mute it and keep the vibra function on, activate the **Silence** mode as described above.

Read your mobile phone number

To read your own mobile phone number, press **▼** when in idle mode and select **Own num.**, then press **OK**, select **Show** and press **OK** again. Your phone number is displayed if present on your SIM card. If not, select **New**, then follow the instructions.

-  If your own number has been stored in the Phonebook, you can read it during a call. See "Consulting the Names list" page 20.

During a call, you can...

Adjust the earpiece volume

During a call, move **◀** to increase the volume, or **▶** to decrease it.

Mute the microphone



Mute

You can mute the microphone so that your correspondent cannot hear you.

During a call, press **OK**, select **Mute** and confirm by pressing **OK**.

Unmute the microphone



Unmute

To unmute the microphone during a call, press **OK**, select **Unmute** and confirm by pressing **OK**. The microphone is unmuted.

Write in the notepad



Notepad

The notepad is a temporary memory in which you can note down a number during a call. To do so during a call, simply enter the number that you want to note. Wait a few seconds for your entry to be stored automatically in the notepad memory. When the call ends, press **OK** to dial it, store it in the **Phonebook**, etc.

Consult the phonebook



View Names List

To consult the phonebook during a call:

- 1 Press **OK**, select **View Names List**, press **OK** and scroll through the entries by pressing **▼** or **▲**.
- 2 Press **CA** twice to return to the in-call screen.

Record a conversation



Record conv.

Only one recording is available, and each new recording (either memo or conversation) will replace the previous one and is available in the menu **Extras > Memo > Play memo**. To record a conversation during a call:

- 1 While one or several simultaneous calls are in progress, press **OK** to access the call context carousel.
- 2 Select **Record conv.** and press **OK**. To end the conversation recording, press **OK**, **CB** or hang up.

 If you select **Mute**, then **Record conv.**, only the caller's voice is recorded. In most countries, conversation recording is subject to law regulation. We advise you to notify the caller if you intend to record the conversation you have with him and only record if he agrees. You should also keep any recording private. 30 seconds is the maximum recording time available (see "Memo" page 59).

Other features during a call

- Change the equalizer settings (see page 29),
- Add a name to the phonebook (see page 41),
- Switch to a handsfree (see page 47),
- Write and send a message (SMS) via the phonebook or the Notepad (see page 48),
- Read a message (see page 49),
- Consult your Call list (see page 52),
- Consult your Organiser (see page 53),
- Check a voice mailbox or access a voice server via the Notepad (see page 76),
- Transmit DTMF tones to answering machines and other devices (see page 76),
- Make a second call (see page 76).

3 • Menu tree

The menus contain all your GSM phone functions. They all feature icons or scrollable lists: press **OK** to enter a menu or sub-menu, press **◀** or **▶** to move left or right in a menu and **▲** or **▼** to scroll in a list and press **OK** to validate an entry or to confirm a choice.

 Oper: Services p75*

 WAP p70

Launch / Favourites / Last page / Favourites / Error messages during WAP connections are mainly due to incorrect parameters: you should contact your operator before first use, in order to have the appropriate WAP and GPRS parameters. With some operators, WAP access parameters can be set remotely. Please check directly by your operator.

 Services + p75

 Service numbers p75

 Images album p24

 Phonebook p41

 Messages p46

 Send a SMS p48

Together with an attachment / Send now / Save

 Read SMS p49

Saved Messages / Received Messages

 SMS settings p50

SMS centre / Signature / Validity period / Reply path / Delivery report / Auto save SMS

 Reset p52

 Broadcast SMS p51

Reception / Topics / District codes

 E-Mail p60

 Settings p61

Network access / E-mail server access / Advanced

 Open mailbox p66

 Send mail p65

 Call list p52

 Call list p52

 Reset p52

 Organiser p53

 Events p53

 Day view p53

 Week view p53

 Month view p53

 Delete past p53

 Extras p56

 Brick game p56

 Call counters p56

GSM counters / GPRS counters

 Euro p58

 Memory status p58

 Calculator p58

 Alarm clock p59

 Memo p59

 Settings p27

 Sounds p27

Ringer / Ringer volume / Key tones / Minute beep / Organiser alerts / Battery low alert / New SMS tone / Vibra alert / Equalizer

 Display p25

Screen saver / Backlight / Animation / Screen animation

 Security p29

Keypad lock / Public names / Call barring / Change codes / PIN protection

 Time and date p31

Clock display / Set date / Set time / Time zone / Daylight savings

 Language p32

 Hotkeys p33

 Voice command p35

 Accessories p32

Car melodies / Speakers / Car kit command / Auto switch off / Auto answer

 Network p35

GPRS attach / Register again / Preferred list

 Call settings p36

Call waiting / Caller ID / Call forward / Autorecall / Any key answer / Mailboxes

 Quick settings p38

 Personal p39

 Silence p39

 Autonomy p39

 Headset p39

 Car p39

 Outdoors p39

 Meeting p39

* Subscription dependent.

4 • Display & images

Introduction

The **Images album** and **Display** menus allow you to select images in a list and display them, as well as set the backlight duration, screen animations, screen saver, etc. In idle mode, press **OK** and select **Image album** for the first option described in this chapter, or **Settings**, then **Display** for the second set of options.

Images album

View all / JPEG / Bitmap / Animations

Settings

Display
Screen saver / Backlight / Animation / Screen animation

Images album



This menu allows you to manage and display the pictures stored in your mobile phone, to **View** or **Delete** them and **Change** their name.

When entering one of the available sub-menus, the pictures stored in your phone are displayed as a text list. To access the graphical display, select a picture in the list and press **▶**. Then press **⏪** or **⏩** to go to the next or previous picture, or **◀** to go back to the text list.

When renaming the file, select it in the list and press **OK** twice. Select **Rename** and press **OK**, enter a name and press **OK**.

The table below gives you an overview of the devices files can be sent to and received from, as well as connection means.

Devices	File type	Sent via...	See...	Example
Mobile to mobile	EMS animation and BMP icon	SMS	"Send an SMS" page 48.	Sent by or received from another mobile phone.
	JPEG	Email	"Get and store attachments" page 67	

Devices	File type	Sent via...	See...	Example
PC to mobile	JPEG pictures, e.g., resized with Mobile Phone Tools.	USB cable	Requires a data connect kit (see page 89).	Photographs taken with a digital camera, files downloaded from the Internet or pictures present on the data connect kit CD-Rom.
	JPEG	Email	"Get and store attachments" page 67	
Network to mobile	BMP icons, JPEG pictures and iMelodies  Wap site dependent	Wap	"Download fun URL" page 79.	By connecting to a "Download fun" Wap site.

 JPEG images must have the correct size and format for your mobile phone to store and display them correctly. Please check "Get and store attachments" page 67 for complete information on this subject.

Display



This item of the [Settings](#) menu gives you access to all options concerning the display, including the management of the screen saver.

Screen saver



Screen saver

Allows you to activate/deactivate the screen saver. When activated, it will run a slide show in idle mode, by using the jpeg file(s) you have stored in your phone and selected (see "Get and store attachments" page 67).

- Select [Settings](#), [Display](#), [Screen saver](#) and press **OK**, then press **◀** or **▶** to select **On** and press **OK**. In the list that appears, select an image by pressing **◀** or **▶** (you deselect it also by pressing these keys), then press **▼** to move to the next image. Once you selected the images of your choice, press **OK** to activate the screen saver.

- 1 You must select several images (up to 10) in order to display a slide show. When selecting only one image to be used as screen saver, only this image will be displayed.
 - 2 Select **Start delay** and press ◀ or ▶ to choose a value between 1 and 5 mn. When in idle mode, the screen saver will start according to the time limit you have set.
 - 3 Then select the screen saver **Display period** (from 10 seconds to 5 mn) and press **OK**. The timing you have set will be applied between each image of the slideshow.
-  *Background images are automatically deactivated when entering an edit screen. Also note that activating this function will automatically deactivate the screen saver.*

Screen animation



Screen animation

Allows you to activate a screen animation that will be displayed in idle mode. Press ◀ or ▶ to select one of the available icons or **Random** to display all icons randomly, then press **OK** to confirm.

 *Activating this function will automatically deactivate the screen saver.*

Animation



Animation

Allows you to activate/deactivate the animation in different menus.

 *Deactivating this function increases the autonomy of your phone.*

Backlight



Backlight

The backlight is activated when receiving incoming calls or messages, browsing lists and menus, etc. Press ◀ or ▶ to set the backlight **Duration** from **Off** to **1 mn backlight** and press **OK** to confirm. Then press ◀ or ▶ to set the **Screen color** from level 1 to level 7 and press **OK** to confirm.

 *Deactivating this function increases the autonomy of your phone.*

5 • Settings & Quick Settings

Introduction

The **Settings** menu allows you to customise your phone and change the settings related to each available option (sounds, time and date, accessories, etc.).

The **Quick Settings** menu allows you to change several settings at once (see page 38).

In idle mode, press **OK** and select **Settings** or **Quick Settings**, then press **OK** to access a feature or option and to change it as described further in this chapter. Press **OK** to confirm or **CB** to cancel.

Settings

Sounds / Display / Security /
Time and Date / Language /
Hotkeys / Voice command /
Accessories / Network / Call
settings

Quick Settings

Silence / Autonomy / Headset /
Car / Outdoors / Meeting /
Personal

Settings

Sounds



This menu allows you to change the ringer volume, select a ringer melody, to set alert beeps and activate or deactivate the vibra alert.

Ringer volume



By default the ringer volume is set to **Medium**. Press ◀ or ▶ to set the volume of your ringer from **Silent** to **Increasing** and use a Hotkey to activate the silent mode (see page 33). The **Silent** mode also applies to key tones.

Ringer



This option enables you to select the ringer tone from the available melodies. Scroll through the list by moving ▲ or ▼ and wait for two seconds to hear the selected melody being played (except for an **Own melody**: press **OK**, select **Playback** and press **OK** again to hear it). Press **OK** to select this melody as ringer, **CB** to cancel, or move to the next melody.

ⓘ You will not hear the melody if the volume ringer is set to **Off** or if the **Silence mode** was activated (see page 19).

- **Downloaded and own melody**

The **Own melod.** menu allows you to store melodies received via SMS, either downloaded from a web site (see below) or received from a friend.

 *To personalise your phone, you can download new ringers by choosing them from your operator's Website. From your personal computer, check on your operator's Internet site the availability, terms and conditions of this service and follow the instructions to download the selected ringer tone via a SMS.*

1 From the **Ringer** menu, select **Own melod.**, then press **OK** to access the list of own melodies. Select one of the own melodies and press **OK**.

2 Select **Send** and press **OK** to send it.

 *This service is subscription dependent; you can only send melodies that are out of copyright. When sending a melody via SMS (see page 49), the receiver must have a Philips mobile phone to be able to hear it.*

3 When receiving a melody together with a SMS, select **Store** to store it as **Own melod.**, and **Rename** or **Delete** it if you wish. Press **OK** to confirm.

Key tones



Allows you to activate/deactivate the key tones. Even if Key Tones are set **Off**, DTMF are played during calls (see page 76).

Minute beep



Allows you to activate a beep, which is emitted 15s before the end of each minute of communication (the beep cannot be heard by the caller). This allows you to manage the duration of your calls.

Organiser alerts



Allows you to activate/deactivate an alert beep when an event you programmed in your organiser is due.

 *Unlike the alarm clock, this alert will not ring if you turn your phone off.*

Battery low alert



Allows you to activate/deactivate an alert beep which informs you that the battery is low and requires recharging.

New SMS tone



Allows you to activate/deactivate an alert beep each time you receive a SMS.

Equalizer



Equalizer

This option allows you to choose from 5 different equalizer settings. You access it while in conversation with a caller: press **OK**, select **Equalizer**, scroll through the list and wait a few seconds to hear the difference. Press **OK** to confirm your choice.

Vibra alert



Vibra alert

Allows you to activate/deactivate the vibrating alert when receiving a call.

Display



This menu allows you to set all features and options related to display. See page 24 for complete information.

Security



This menu ensures the security of your phone by locking the keypad, limiting calls to public numbers, prohibiting specific incoming and outgoing calls, activating security via PIN codes and changing those PIN codes.

Keypad lock



Keypad lock

Allows you to activate/deactivate the keypad lock. When your keypad is locked, you can unlock it by pressing and holding the **CA** key when in idle mode. The keypad automatically unlocks when receiving a call.

 *Even when your keypad is locked, you can still place an emergency call (see page 46).*

Public names



Public names

Allows you to manage a specific names list, called **Public Names** list, and restrict calls to this list via the **Call restriction** option.

 *This feature is subscription dependent and requires a PIN2 code (see page 31).*

- **Call restriction**

Allows you to activate/deactivate the call restriction to the **Public Names** list. When activated, you can only access the names present in the **Public names** list, as opposed to the **Phonebook** of the main menu.

 *This function is subscription dependent and requires a PIN2 code (see page 31). Please note that when activating this option, it might also apply to WAP and e-mail connections over GPRS.*



Call restriction



Public names

- **Public names**

Allows you to consult and modify your **Public Names** list. You can enter a new name, modify or delete a name in the list via PIN2 code.

Use the **<New>** option to enter the name and phone number of a new name (see “Text or number entry” page 4). Then select the number type: **Phone**, **Fax** or **Data**. Names in this list can be changed or deleted.

Call barring



Call barring

This menu allows you to limit the use of your phone to specific calls by letting you bar both outgoing and incoming calls. This function is network dependent and requires a call barring password supplied by your service provider.



Outgoing calls

- **Outgoing calls**



All calls

-



International

-



Inter. except/home

-



Cancel

The **Outgoing** menu allows you to select between **All calls**, **International calls** and **Inter. except/home** calls (the latter allowing you to call your home country when you are abroad). You can also **Deactivate** the bar on outgoing calls.

These menus then allow you to bar, within each available option, **All calls**, **Voice calls**, **Data calls** or **Fax calls**.



Incoming calls

- **Incoming calls**



All calls

-



When Roaming

-



Cancel

The **Incoming** menu allows you to select **All calls** or **When roaming**. It also provides access to the **Cancel** menu to remove bar on incoming calls.

These menus then allow you to bar, within each available option, **All calls**, **Voice calls**, **Data calls** or **Fax calls**.



Status

- **Status**

In each sub-menu (All calls, When roaming, etc.), the **Status** option allows you to know whether a type of call is barred or not.

Change codes



Change codes

Allows you to change your PIN 1, PIN 2 and call barring codes.

PIN protection



Allows you to activate/deactivate the PIN protection when switching on your phone. When the PIN code is activated, you will be asked to enter your PIN code when switching your phone on.

 *If your PIN code is deactivated, you cannot change it.*

PIN2 code

Depending on your SIM card, some features or options may require a PIN2 secret code. This is a second secret 4 to 8-digit code given to you by your operator. If you enter a wrong PIN2 code 3 times, your SIM card is blocked. To unblock it, request the PUK2 code from your operator or retailer.

 *If you enter an incorrect PUK code 10 times in a row, the SIM card will be blocked and unusable. If this happens, contact your operator or retailer.*

Time and date



This menu allows you to set the time and date, time zone, daylight savings, and change the clock display mode.

Clock display



Allows you to select **Analogue** or **Digital** time formats when shown in idle mode, by pressing ◀ or ▶. In both cases, press  to confirm.

Set date



Allows you to set the date by pressing the appropriate numeric keys (you can also set the date by moving ▲ or ▼).

Time zone



 *The time zone and daylight savings are to be set first. You should then double-check date and time if previously set. To know which time zone you are in, we recommend you to check in an atlas or an encyclopedia.*

The **Time zone** option allows you to set the time zone you belong to, according to GMT (Greenwich Meridian Time). Move ▲ or ▼ to select the setting corresponding to your area, e.g. GMT + 00:00 when located in United Kingdom, GMT + 01:00 when in The Netherlands, France or Germany.

Daylight savings



 *This setting only concerns countries in which time is set according to summer/winter time (e.g. Greenwich Meridian Time / British Summer Time).*

This option allows you to set the daylight savings to **On** (in summer time) or **Off** (in winter time) by moving ◀ or ▶. As this setting impacts the date and time option, it should be set first. If daylight saving is **On** and you set the time to 12:00, it will automatically switch to 13:00 when turning the option to **Off**.

Set time



Allows you to set the time by pressing the appropriate keys or moving ◀ or ▶ to increase or decrease the time minute by minute.

Language



This menu allows you to select a language for all menu text. A long press on ☺ when in the idle screen automatically displays this menu.

Accessories



This menu becomes available the first time an accessory (see page 88) is plugged in. It allows you to set all parameters linked to their use.

Car melodies



Allows you to select the incoming call melody to be played by the car kit. Several melodies are available: the ones that are specific to the car kit, and the one you have previously chosen for your phone.

Speakers



Allows you to listen to your phone conversations, either through the car kit speaker or the radio speaker if available.

Car kit command



Allows you to activate the voice dial via a voice tag. The phone plugged on the car kit, use this menu to program the voice command by following the on-screen instructions. Once the voice command is defined, the car kit will emit a beep and activate the voice dial as soon as you pronounce the voice tag (“Voice dial” page 17).

Auto switch off



Allows you to automatically switch off the phone, either immediately, 30 second, 5 minutes or 3 hours after turning the car ignition off.

Auto answer



Allows you to select the automatic answering of incoming calls. You can set a delay for automatic answering from 5 to 15 seconds.

Hotkeys



Instead of entering the various menus and browsing the lists, you can set a direct access to a specific function by linking it to a Hotkey, so that a long press on this key will automatically activate this function.

ⓘ You can only program keys to , as keys (select language) and (retrieve voice mailbox) are predefined and cannot be changed.

- To set a hotkey, press , select **Settings > Hotkeys** and press .
- Select a key from to and press .
- Browse the list to select the function you wish to associate with this key. Press to confirm your choice.





























ⓘ If the selected key is already set, you can reprogram it: press twice, select **Change** and press . This will bring you to the list of available functions.

- To use the hotkeys, simply press and hold the key corresponding to the function you want to launch or activate while in idle mode.

ⓘ You can also set hotkeys for voice dial (see “Voice dial” page 17). Depending on your service provider some Hotkeys, in addition to and , can be predefined and locked, preventing reprogramming.

You can associate hotkeys to to the functions of the following table.

Flash Dial	Dials the associated number of the Phonebook.	Keypad lock	Locks / unlocks the keypad.
Activ. Silence	Activates the silence quick setting (vibra on, ringer volume off).	Activate Car	Activates the car quick setting (ringer volume high, any key answer).
Activ. Headset	Activates the headset quick setting (ringer volume medium, any key answer on).	Meeting	Activates the meeting quick setting (vibra on, ringer and all keys set to silent).
Activ. Outdoors	Activates the outdoors quick setting (ringer volume high, keypad lock on with a 1mn delay).	Activ. Personal	Activates the personal settings.
Redial last num.	Redials the last number called.	Reply last num.	Redials the number of the last call received.

 Calculator	Direct access to the calculator.	 SOS call	Dials the emergency call number.
 To voice mail	Forwards all calls to the voice mailbox.	 Read SMS	Displays the messages list.
 Activ. Autonomy	Activates the autonomy quick setting, which extends the battery autonomy (animation off, vibra on, backlight off, ringer volume medium).	 Synchronise	Runs a synchronisation of your phonebook and/or organiser with a PC application.  Requires a Data connect kit (page 89).
 Send SMS	Opens the Messages menu.	 Show events	Displays the event list of the Organiser menu.
 Record memo	Allows to record a memo.	 Play memo	Plays the memo back.
 E-mail	Opens the E-mail menu for access to the mailboxes.	 Add new event	Opens the Add event menu of the Organiser.
 Launch	Launches a WAP session.  <i>Subscription dependent</i>	 Accum. cost	Displays the accumulated cost of outgoing calls.  <i>Subscription dependent</i>
 Brick Game	Direct access to the Brick Game .	 Show balance	Displays the remaining credit balance.  <i>Subscription dependent</i>
 Alarm Clock	Opens the Alarm menu.	 Screen color	Open the Backlight colours menu.
 Screen saver	Opens the Screen saver On/Off menu.	 Images album	Open the Images Album menu.
 -> Euro	Direct access to the Euro converter (from currency).	 Euro ->	Direct access to the Euro converter (to currency).
 Phonebook select.	Opens the Phonebook select menu.	 Brick game	Opens the Brick Game .  <i>Subscription dependent</i>

Voice command



Voice command menu allows you to quickly activate a specific function: instead of programming a hotkey, you simply set a voice tag that will activate a feature when you pronounce the associated word. You can associate a Voice command to the functions supported by the Hotkeys (see page 33).

- 1 To set a voice tag for voice command, press **OK**, select **Settings > Voice command** and press **OK**.
- 2 Select **<New>** and press **OK**, then browse the list to select the function to be set with a voice tag. Press **OK** to confirm your choice.
- 3 When **Press OK and speak** appears, follow the instructions displayed on the screen. When prompted to record your voice tag, make sure you are in a quiet environment, choose a short and simple word and clearly pronounce it.
- 4 The next carousel menu allows you to **Delete** or **Play** the voice tag, **Change the function** associated with this voice tag or **Change the voice tag** used for this function.
- 5 Repeat the steps described above to add more voice commands. Then make a short press on **CB** to go back to the previous menu or a long press to go back to idle.
- 6 To activate a feature using the voice command, press and hold **OK** when in idle mode, then say the recorded voice tag.

Words recorded as voice tags can be played, changed or deleted at any time. You can also set a voice tag for a voice dial instead of a voice command (see “Voice dial” page 17).

-  *The duration of a voice tag is 2 seconds. Up to 40 voice tags can be defined and shared between voice dial and voice command.*

Network



This menu allows you to handle the connection between the phone and the network, register manually the available networks and manage your preferred networks.

GPRS attach



Your mobile integrates features that support GPRS (Global Packet Radio Service), a new mobile service allowing you to exchange data with high speed

rates and to stay always online (i.e. have a permanent connection to the Internet and WAP). Your phone allows you to fully benefit from GPRS access in WAP and Internet.

- **Contact your phone operator** to have full information about GPRS availability over his network and for an appropriate subscription. You might also need to configure your phone with the GPRS settings supplied by your operator, by using the menus described in this section.

This menu allows you to define the attach mode of your mobile phone to the GPRS service:

- **Always on**
Your phone will always register to the GPRS service. This option allows faster GPRS connection. However it will increase energy consumption.
 - **For data calls**
Your phone will automatically register to the GPRS service only when required. This option allows to reduce energy consumption, however it will increase the connection delay.
- **In spite of these settings, you must still select the bearer (GSM or GPRS) in the menus of each application to be used (WAP or data transfer).**

Register again



Provides you with a list of the networks available in the area when the manual mode is selected. Select the network you want to register with and press **OK** to confirm.

Preferred list



Allows you to build a network list in order of preference. Once defined, the phone will try to register on a network, according to your preferences.

Call settings



This menu allows you to set all the call options (call forward, waiting, etc.).

Call forward



Allows you to divert incoming calls either to your mailbox or to a number (whether in your **Phonebook** or not) and applies to:



-  Before activating this option, you must enter your voice mailboxes' numbers (see "Mailboxes" page 37). This feature is subscription dependent, and different from the call transfer, which takes place when one/several calls are in progress.

- **Unconditional**

The unconditional option will divert all the incoming calls.

-  **Warning!** When selecting this option, you will not receive any calls at all until you deactivate it.

- **Conditional**

This option allows you to choose in which circumstance(s) you want to divert incoming calls. Three options are available: **If no reply** (you haven't replied to the call), **If not reachable** (your network isn't available) or **If busy** (you are already on the phone and your subscription doesn't include the call waiting option or you haven't activated it). Each option can be set independently.

Once you selected either **Conditional** or **Unconditional**, choose whether you want to divert calls to your voice mailbox or to another phone number, or cancel the call forward.

- **Status**

Allows you to display the status of all call forwarding.



Status

Mailboxes



Mailboxes

This menu allows you to enter your voice mailbox numbers if not available on your SIM card.

-  In some cases, you might have to enter two numbers: one to listen to your mailbox, the other one to forward calls. Contact your operator for complete information on this subject.

Autoredial



Autoredial

Allows you to activate/deactivate the autoredial feature. If autoredial is switched on and if the line is busy, your phone automatically continues to redial this number until a successful connection is made, or until the maximum number of attempts is reached (10). The phone shall emit one beep at the beginning of each attempt and one special beep if the connection is successful.

-  The time between redials increases with each attempt.

Any key answer



Any key answer

Allows you to accept a call by pressing any key, except , used to reject a call.

Call waiting



Call waiting

Call waiting is managed differently depending on the type of network you selected.



With GSM call

- **With GSM call**

Allows you to activate or deactivate the call waiting and applies to:



When this option is active, you hear a beep if someone tries to call you while already in communication.

 *This function is subscription-dependent. Contact your operator.*



With GPRS call

- **With GPRS call**

Allows you to **Activate** or **Deactivate** the call waiting for voice incoming calls.

Caller ID



Caller ID

Allows you to show or hide your identity to your correspondent. The **Status** option will inform you if this function is activated or not.

 *This function is subscription and network dependent. Contact your operator.*

Quick settings







This menu allows you to access a group of predefined settings, which let you quickly adapt your phone to your environment by changing several settings at once. For example, selecting **Meeting** will set your ringer volume to silent, activate vibra and deactivate the key tones (the other items are set according to the settings you configured). When your meeting is over, selecting **Personal** will reactivate all your usual settings.

 *You can also associate a quick setting with a hotkey (see page 33).*

Quick settings

Warning! * The settings listed in the first column are the default settings (preset in the factory). As you can change each of them, they might be different from the ones listed below. In both cases (whether you changed parameters or





not), these settings are stored in the **Personal** menu item and apply to each box of the table.

	 Personal	 Silence	 Autonomy	 Outdoors	 Meeting
Vibra alert	Active*	Active	Inactive	<input type="checkbox"/>	Active
Ringer volume	Medium*	Silent	Medium	Loud	Silent
Key tones	Active*	Inactive	<input type="checkbox"/>	<input type="checkbox"/>	Inactive
Organiser alerts	Active*	Inactive	<input type="checkbox"/>	<input type="checkbox"/>	<input type="checkbox"/>
Battery low alert	Active*	Inactive	<input type="checkbox"/>	<input type="checkbox"/>	<input type="checkbox"/>
New SMS tone	Active*	Inactive	<input type="checkbox"/>	<input type="checkbox"/>	<input type="checkbox"/>
Backlight	10 sec*	<input type="checkbox"/>	Inactive	<input type="checkbox"/>	<input type="checkbox"/>
Any key answers	Inactive*	<input type="checkbox"/>	<input type="checkbox"/>	<input type="checkbox"/>	<input type="checkbox"/>
Animation	Active*	<input type="checkbox"/>	Inactive	<input type="checkbox"/>	<input type="checkbox"/>

Accessories settings

When connecting an accessory, the settings described in the table below also become available in the **Quick Settings** menu.

 When disconnecting the accessory, the phone goes back to the **Personal Quick Setting** (see table above).

	 Headset	 Cigarette Lighter Adapter or Fast charger	 Data	 Car
Vibra alert	<input type="checkbox"/>	Inactive	Inactive	Inactive
Ring volume	Medium	<input type="checkbox"/>	<input type="checkbox"/>	Loud
Key tones	<input type="checkbox"/>	<input type="checkbox"/>	<input type="checkbox"/>	<input type="checkbox"/>
Organiser alerts	<input type="checkbox"/>	<input type="checkbox"/>	<input type="checkbox"/>	<input type="checkbox"/>
Battery low alert	<input type="checkbox"/>	<input type="checkbox"/>	<input type="checkbox"/>	<input type="checkbox"/>
New SMS tone	<input type="checkbox"/>	<input type="checkbox"/>	<input type="checkbox"/>	<input type="checkbox"/>
Backlight	<input type="checkbox"/>	<input type="checkbox"/>	<input type="checkbox"/>	Active
Any key answers	Active	<input type="checkbox"/>	<input type="checkbox"/>	Active
Animation	<input type="checkbox"/>	<input type="checkbox"/>	<input type="checkbox"/>	<input type="checkbox"/>

6 • Phonebooks

All operations described in this chapter require you have selected the relevant Phonebook, whether in SIM or in phone.

The present chapter describes how to manage phonebooks. Please refer to “Calls and messages” page 46 for further information on how to call numbers and send messages.

Introduction

Your mobile phone has two phonebooks. The SIM phonebook is located on the SIM card and the number of entries depends on the card capacity.

 *The SIM card capacity depends on the type of card you have. Please check with your local dealer for full information on this subject.*

The second phonebook is built in the mobile's memory and can hold up to 300 names with several types of information, as described below.

 *The phonebook located on your phone shares the mobile capacity and memory with the organiser and the image album. As such, both features are inter-dependent: the more names you create, the less events you can store and vice-versa. 300 is the maximum number of names and events cards.*

To check the memory available in your phone, press  when in idle mode to access the main menu, then select **Extras > Memory**.

Phonebook

View names list^o

Phonebook settings

Phonebook select.

In phone

In SIM

Groups setting

Select melody /

Select picture /

Rename

Reset phonebook*

Copy all to phone[⌘]

 ^o) Displays the names list of selected phonebook (in SIM or in phone).

^{*)} This option does NOT apply to SIM phonebook.

[⌘]) Will copy the content of your SIM card into your phone. Selecting this option twice will duplicate all the names.

Phonebook



The **Phonebook** menu allows you to select one of the two available phonebooks: the one on your SIM card or the one in your phone. When entering new names in the **Phonebook**, they will be added to the phonebook selected in this menu.

Phonebook in SIM card



Press **OK** and select **Phonebook**, **Phonebook settings**, **Phonebook select**. Then press **◀** or **▶** to select the phonebook located in your SIM card. Names added to this phonebook can then be copied into the phonebook located in your phone.

When you copy the contents of your SIM phonebook into your phone (see below), you can still use the phonebook of your SIM card, even though it features less fields of information. For a complete description of the SIM phonebook and how to add names to it, see “Add names in the phonebook” page 41.

ⓘ *Your mobile phone only manages one phonebook at a time and will ignore the information relative to the other one: e.g., if "Smith" is present in both phonebooks and if you delete it in the phone, it remains unchanged in the SIM.*

Phonebook in phone



The default selected phonebook is the one located in your phone. It can hold up to 300 names and be reset at once using the **Reset phonebook** option. Depending on SIM card capacity, names added to this phonebook can then be copied into the SIM phonebook (see “Copy to SIM” page 45).

If you are using a SIM card for the first time, follow the standard SIM card installation procedure as described page 8, then go to the section titled “Add names in the phonebook” below.

Add names in the phonebook

In the SIM card

To add a name in the SIM phonebook, proceed as follows:

- 1 Press **▼** to enter the phonebook, select **New**, then press **OK**.
- 2 Enter the name, then the number of your choice and press **OK**.

- B** A number can contain a maximum of 40 digits, depending on your SIM card. Entering all numbers, including local ones with international prefix, country code and area code will allow you to dial them from any location.
- 3 Select the type of number allocated to the name: **Phone**, **Fax** or **Data** and press **OK** to confirm and store this name in your phonebook.

In the phone

The phonebook located in your phone holds more information fields than the SIM phonebook, and handles:

- First and last names fields up to 20 characters
- Numbers fields (Mobile, Work, etc.) up to 40 digits and 1 "+"
- Extra fields (e-mail and note) up to 50 characters
- Group selection

You can create up to 300 records holding up to 5 numeric fields of your choice (e.g. 2 mobile numbers or 3 work numbers for the same name) out of a maximum of 7 fields.

- 1 Press **OK** and select **Phonebook**, **New**, then press **OK**.
- 2 Enter the last, then the first name of your choice and press **OK**.
- B** One of the two name fields can be empty, but not both. To go back to the previous field, press **←**.
- 3 In the **New field** carousel, select the number type of your choice (Mobile, Fax, Data, Pager, Home, Work) or one of the two alphanumeric fields (Note, e-mail) and enter the relevant number or text. Then press **OK** to save this new record.
- 4 If you wish, then select the **Group** this name will belong to and press **OK** to confirm. By selecting Phonebook, Phonebook settings, then Groups setting, you can associate a specific **Melody** and **Picture** to each available group, as well as **Rename** groups. In all cases, press **OK** to save settings or changes (see "See & hear who's calling: Fotocall" page 16 for complete information).





When receiving a call from a contact associated to a group, the melody and/or picture defined for this group will automatically ring and/or appear on the screen.

Own number

The "Own number" item that appears in the phonebook should contain your own phone number(s). If not, we advise you to enter your mobile number(s) as well as any other relevant information.

 Although all its fields can be empty, the "Own number" item cannot be deleted.

Edit and manage names

Once you have stored names in your phonebook, press  when in idle mode to access the **Phonebook**. Thanks to the built-in predictive editor, you can search for a name in the phonebook the same way you enter it (see page 4): when the names list is displayed on screen, quickly press -only once- each key corresponding to the first letters needed to spell a name (e.g.,    for "mar" starting "Martin"). Keystrokes input are analysed and the name starting with these letters is selected in the list. Depending on the phonebook you have selected, you will have access to part or all of the following options:

- call or call handsfree
- delete
- copy to phone
- associate a voice dial
- change name
- copy to SIM
- flash dial
- send a message
- show
- change type
- make default
- include in a group





In the SIM card

Select a name in the SIM card phonebook, then press  to access one of the following options:

- **Delete** to delete the selected name and number,
- **Change** to change the selected name and all related information,
- **Copy to phone** to copy the selected name and all related information into the phonebook located in your phone.

In the phone

Add a field

- 1 To add a new field to an existing record, select the name of your choice, select **Show** and press .
- 2 Select **<New>** and press . Choose the type of field to be added and press . Enter the number or text, then press  to save changes.

- Repeat steps 1 and 2 to add up to 6 fields to the same record. Make a short press on **⏪** to go back to the previous menu, or a long press to go back to idle mode.
- ⓘ** Numbers or text will appear in order of creation date. The first fax or phone number you enter becomes the default number. As such, it appears in first position in the list. To make another number default, see “Make default” page 44. Alphanumeric fields (note and e-mail) can only be changed or deleted.

Change a field content



Show

- To change the content of a field in an existing record, select the name of your choice, press **OK**, select **Show** and press **OK** again.
- Then select the field to be changed in the list, press **OK**, select **Show** and press **OK** again; the details of the selected field appear (number entered, check mark icon if it is the default call number, icon corresponding to the type of number, etc.). Press **OK** to access the next carousel.
- In the carousel that appears, select **Change** and press **OK**. Make the changes wanted and press **OK** to save them.



Change

Change a field type



Change type

- ⓘ** If you copied your SIM phonebook into your phone, some numbers might appear as being of “No type” and don’t have any icon. “No type” numbers can only be changed: follow the procedure described below to define a type for these numbers or to change the type of any other saved number.

To change a field type of an existing record, repeat steps 1 to 3 of the “Change a field content” paragraph. Then select **Change type** in the carousel menu, select the new type of number and press **OK** to confirm your choice.

Delete a field



Delete

To delete a field of an existing record, repeat steps 1 to 3 of the “Change a field content” paragraph. Then select **Delete** in the carousel menu, and press **OK** to confirm.

Make default



Make default

The first number you enter when creating a new record becomes the default number: it will appear first on the fields list and is automatically called when pressing the pick-up key or when pressing **OK** and selecting the **Call**, **Call handsfree** or **Send SMS** option.

To change the default number (e.g. make the "Work" number default instead of the "Home" number), repeat steps 1 to 3 of the "Change a field content" paragraph. Then select **Make default** in the carousel menu, and press **OK** to confirm.

Copy to SIM



Copy to SIM

As mentioned earlier, entering names in the SIM phonebook can be useful if you change phones frequently. If you copy phone numbers into the SIM card, your phonebook is always updated when switching phonebooks or when using another phone.

To copy a number into the SIM card phonebook, repeat steps 1 to 3 of the "Change a field content" paragraph. Then select **Copy to SIM** and press **OK**.

7 • Calls and messages

Introduction



The **Phonebook** menu features information related to each name stored in the selected phonebook.

 If the entries are different from one phonebook to the other, the Phonebook menu contents may vary.



As for the **Messages** menu, it allows you to manage the messages in your voice mailbox,

short messages (SMS) to be sent or read, the settings for all messages including broadcast messages. You can delete all messages at once via the **Reset** command.

Phonebook

[Phone phonebook selected]

<New>

Last name > First name > Pager / Home / Work / Mobile / Fax / Data / Note / e-mail > Group

[Name selected]

Change name / Call / Call handsfree / Send SMS / Delete / Show (Copy to SIM, Voice Dial, Flash dial, Make default, Change type) / Select group

[SIM phonebook selected]

<New >

Enter name > Enter number > Number type > Data/Phone/fax

[Name selected]

Call / Call handsfree / Send SMS / Voice dial / Flash dial / Delete / Change / Copy to phone

Messages

Send SMS / Read SMS / SMS Settings / Reset / Broadcast SMS

Call a number

Emergency number





The emergency number will call the nearest emergency centre of your area. In most cases, you can call this number even when your keypad is locked and if you haven't entered your PIN code yet.



 Depending on the network operator, the emergency number can be dialled without the SIM card being inserted. 112 is the standard emergency number for Europe (also for UK: 999).

- 1 To call this number, enter it in idle mode by pressing the corresponding keys, **or** press  and select **Phonebook > Emergency number**.
- 2 Press  to dial and press  to hang up.

Other number

Enter a number

In idle mode, enter a number by pressing the corresponding keys. Press  to dial and press  to hang up.

-  Pressing  will let you access a carousel allowing you to call this number, store it or send a SMS.

Select a name













Call

-  For your own comfort and safety, ensure you move the phone away from your ear when calling handsfree, especially when increasing the volume.





Call handsfree

- 1 Press  and select the record of your choice.
- 2 If you selected the phonebook in your SIM card:
 - once the record is selected, simply press  to call, **or**
 - press  twice to access the next carousel, then select **Call** or **Call handsfree** and press  to dial the number.
- 3 If you selected the phonebook in your phone:
 - To call the **default** number:
 - once the record selected, simply press  to dial, **or**
 - press  to access the record carousel, then select **Call** or **Call handsfree**.
 - To call any other number, choose **Show** once the record is selected and choose a number type in the list (Mobile, Home, etc.). Press  to access the next carousel and select **Call** or **Call handsfree**.
- 4 In all cases, press  to hang up.
 -  You can also switch to handsfree while a standard call is in progress: press , select **Activ.h/free** and press  to confirm.

Use Flash dial



Flash dial

In idle mode, press and hold a key between  and  to dial the associated entry (see “Flash dial” page 16): connection is established. Press  to hang up.

Use Voice dial



In idle mode, press and hold **OK**, then pronounce the saved voice tag (see “Voice dial” page 16). If the phone recognizes the voice tag, it dials the number associated with it. Press **END** to hang up.

Messages



In addition to calling people, you can also send them text messages, called SMS, together with a melody or an emotion icon (optional). These short messages can be sent to any correspondent (saved in the phonebook or not) and are displayed on their mobile phone screen when received.



The **Send SMS** item of the **Messages** menu allows you to:

- send a standard or customised short text message to someone,
- edit the last message sent to modify it if needed and send it again,
- add an iMelody, pre-defined sounds, an animation or a picture to your message.

The Standard SMS messages are displayed one after another: **Please call me back at...** for example allows you to select a pre-configured message including your number; if this number is the first one of the **Own num.** option (see page 46).

Send a SMS

To a name in the list

- **To the default number if several (phonebook in phone) or to the unique phone number (phonebook in SIM)**
 - 1 Press **▼**, select the name of your choice and press **OK**.
 - 2 Select **Send SMS** and press **OK**, then select the type of message to be sent and press **OK**. Enter your message, attach a graphic or a sound if you wish, then select **Send now** or **Save** (see below).
- **To the number of your choice (phone name list only)**
 - 1 Press **▼** and select the record of your choice, then press **OK**, select **Show** and press **OK**.
 - 2 Select the number of your choice and press **OK**.
 - 3 Proceed as described in step 2 of the previous paragraph.

To any other name

To send a short message to someone whose number isn't stored in the phonebook, press **OK** and select **Messages**, then **Send SMS** and **New**. Enter the

phone number to which the message should be sent to and press **OK**. Then follow the instructions described above to send a message.

Together with an attachment

This option allows you to attach a sound, icon or animation to your message. Depending on the type of file you want to attach, select **Add graphic** to attach a bitmap image or an animation, and/or **Add sound** to attach a melody. Select the sub-menu of your choice, then one of the available items in the list that appears, and press **OK** to confirm and attach it to your message.

B You can send up to 2 attachments of 2 different types together with your SMS. Animations and pictures are exclusive: if you first select an animation, then a picture, only the picture will be taken into account and vice-versa.

Some icons, animations and sounds are pre-defined and shipped as standard with your mobile phone. Personal pictures and sounds, e.g., that you have received via SMS or e-mail and then stored in the relevant menus, will automatically appear in the "Own" sub-menus (Own melodies, Own animations, etc.). You cannot send "Own" items via SMS when they are copyright-protected.

Send now



Allows you to send the current message once you entered it (to learn how to enter text and numbers, see page 4). Press **OK** to confirm.

Save





Allows you to store the current message and its associated icon and melody if any. Press **OK** to confirm.

Read SMS



The **Read SMS** item of the **Messages** menu allows you to consult the list of SMS you have saved and received, as well as delete, reply, re-send or forward these messages.



Received Messages

The messages you received and already read are labelled with . Messages received but not yet read are labelled with . Select a message and press **OK** to read it. When displayed, press **OK** to access the following options:

- **Reply** to the sender and send him a message,
- **Forward** the selected message (choose the recipient in the phonebook or enter a phone number manually; you cannot modify a forwarded SMS),
- **Delete** the selected message,

- **Store number** of the sender if it is attached to the message,
- **Store melody** if a melody was sent together with the SMS (see “Downloaded and own melody” page 27),
- **Store graphic(s)** if one or several graphics and/or animations were sent together with the message,
- **Extract** a number included in the message itself, if this number is included in double quotes (several numbers can be included and extracted),
- **Call** the sender of the message (operator-dependent).

Saved Messages

The messages you sent are labelled with  in normal mode or with  in auto save SMS mode (see page 51). Select the message you want and press **OK** to read it. When displayed, press **OK** to access the options described above in “Received Messages”, including storing the caller’s number.

Clear SMS



Reset

The whole SMS list can be cleared at once: press **OK** and select **Messages**, then **Reset**. Press **OK** again to reset the SMS list.

 *Deleting your SMS list is useful to free memory space in order to store new messages.*

SMS settings



SMS settings

This menu allows you to customise your SMS via the options described below.

SMS centre



SMS centre

Allows you to select your default SMS centre. **If not available on your SIM card, you must enter your SMS centre number.**

Signature



Signature

Allows you to sign your SMS. This signature consists of a series of characters showing your default “Own number”. This forms a signature that is transmitted at the end of your message. The length of the message is consequently reduced. You can edit the signature, modify and save it.

Validity period



Validity period

Allows you to select the length of time your message is to be stored in your SMS centre. This is useful when the recipient is not connected to the network (and thus cannot receive your message immediately).

 *Subscription dependent.*

Reply path



Reply path

You can activate or deactivate this option, which allows you to transmit your SMS message centre number with the message. Your correspondent can then reply using your own SMS centre and not theirs. This speeds up the rate of transmission.

 *Subscription dependent.*

Delivery report



Delivery report

You can activate or deactivate this option which informs you via a written message whether your SMS was received or not.

 *Subscription dependent.*

Auto save SMS



Auto save SMS

Allows you to activate or deactivate the automatic saving of messages sent.

Broadcast SMS



Broadcast SMS

This menu allows you to activate or deactivate the reception of SMS broadcast by the network to all subscribers. When activated, this service causes the mobile to listen to messages which are regularly transmitted to all subscribers on the network.

Reception



Reception

Allows you to activate/deactivate the reception of cell broadcast messages. When selecting **On**, you must define one or several topics as described below.

Topics



Topics

Allows you to define the type of messages you want to receive. To define a new type, select **<New>**, enter the code provided by the operator, and, if desired, associate a name. If you select an existing type in the list, you can change or delete it. You can enter up to 15 different types in the list. To obtain the codes corresponding to the different types, contact your operator.

District codes



District Code

Allows you to select the type of messages you would like to be permanently displayed on the idle screen. As a result, for this special handling of the message, you must enter the type in both the **District code** and the **Topics** menu.

Call list



This menu provides you with the list of outgoing and incoming calls, as well as attempts at auto redialling and call details. The calls made, missed and received are displayed in chronological order with the most recent on top of the list. When the Call list is empty the screen displays **List empty**.

Display



Call list

Press **OK** then select **Call list** and press **OK** twice to display the call list. Press **OK** again to consult the date, time, number, call status of any selected call and to know if it was sent or received. Press **OK** for access to a carousel which allows you to **Call** or **Call handsfree** this correspondent, **Send a SMS**, **Delete** the selected call or **Store** the associated number.

B You can directly access the Call list by moving **▲** while in idle mode. You can also select a record in the Call list and press **☎** to dial the corresponding number.

Reset



Reset

Press **OK**, select **Call list**, then **Reset**. Press **OK** to reset the Call list.

8 • Organiser & Extras

Introduction



Your mobile phone features an **Organiser** which allows you to manage and co-ordinate various events including meetings.

Events can be viewed in different ways (day, week or month views), can be changed or deleted at any moment, as well as repeated according to specific frequencies. The "Organiser alerts" (see page 28) allow you to be alerted by a beep when events are due (e.g., 5 mn before a meeting).

Also, data exchanges and synchronisation of your organiser can be performed via a USB cable connected to your phone and to the external device.



As for the **Extras** menu, it features easy-to-use items such as a Calculator, an Alarm clock, Call

counters which will let you manage your call costs, Euro converter, memo and conversation recording.

Organiser

Events

<New>

Holiday / Meeting / ToDo

[Event selected]

Delete / Change

Day view

Week view

Month view

Delete past

Extras

Call counters / Euro Converter/

Brick game* / Memory status /

Calculator / Alarm clock /

Memo



* This menu can be subscription dependent. As such its icon and content may vary.



Organiser

Creating a new event



This menu allows to create events and store them in your organiser. Events can be **Meetings**, **Holidays** or **ToDos**. When the organiser alert is On (see page 28), a beep alerts you when an event is due.

- 1 Press **OK**, select **Organiser > Events** and press **OK**.
- 2 Select **<New>** and press **OK**.
- 3 Select the type of event to create (**Holiday**, **Meeting**, **ToDo**) and press **OK**.
- 4 Enter the starting and ending date & time of the event and press **OK**, enter the text concerning the event (e.g. "Meeting with Smith") and press **OK**.



- 5 The **Set Reminder** menu reminds you of events via alerts triggered at times you choose. Moving ◀ or ▶, set the **Reminder** for this event and press **OK**.
-  This menu only applies to **Meeting** and **ToDo** events. Note that the reminder depends on the time set and displayed on the screen. As such, it will be updated when changing time zones (see “Time and date” page 31).
- 6 Move ◀ or ▶ to set the **Repeat Event** option for this event and press **OK**.
- 7 The events will be listed using start times and date. Back to the events list,
 - press and hold **CB** to go back to idle mode, or
 - repeat steps 2 to 7 to create as many events as needed.
-  The organiser shares the mobile capacity and memory with other features (phonebook, picture album, voice memo, etc.). As a consequence, all features are inter-dependent: the more events you create, the less names, memos or images you can store, and vice-versa. 299 is the maximum total of events + names you can store.
 If “List full” appears, delete an event (or name) to be able to create a new one. To check the memory available in your phone, press **OK** and select **Extras**, then **Memory status**.

Modifying an event

Changing an event



Change

-  When creating an event, some fields are not available to help you create it more quickly. Nevertheless, they become available when changing that event.
 - 1 To change an event, press **OK** and select **Organiser**, **Events**, then the event of your choice and press **OK**.
 - 2 When your phone displays the details of the selected event, press **OK**, select **Change** and press **OK** again.
 -  Changing a repeated event will also modify all instances of this event: in this case, press **OK** to confirm.
 - 3 Change any information as needed and as described above.

Deleting an event



Delete

- **Deleting a single event**
 - 1 Press **OK** to enter the main menu, select **Organiser**, **Events**, then the event of your choice and press **OK** twice.

2 Select **Delete** and press **OK** to confirm.

- **Deleting a repeated event**

By selecting a past occurrence

1 Press **OK** and select **Organiser**, **Events**, then a past occurrence of an event and press **OK**.

2 When the event details appear, press **OK**, then select **Delete** and press **OK** to confirm: only the past occurrences of the selected event are deleted.

By selecting a future occurrence

1 Press **OK** to enter the main menu, select **Organiser**, **Events**, then a future occurrence of an event and press **OK**.

2 When the event details appear, press **OK**, then select **Delete** and press **OK** to confirm: all occurrences of the selected event are deleted.

Deleting passed events



You can also delete past events by selecting **Delete past** at the first level of the **Organiser** menu. To do so, proceed as follows:

1 Press **OK**, select **Organiser** > **Delete past**, and press **OK**.

2 Enter the starting date (past or future) from which all previous events will be deleted and press **OK**.

3 Press **OK** to confirm. In this case, all events preceding this date will be deleted.

 *To delete all events set in your organiser, enter a starting date several years ahead (e.g., 12/31/2010). This way, you make sure all events preceding this date are deleted at once.*

Views of events



The **Day view**, **Week view** and **Month view** display in the selected format all events stored in your organiser. To display events in these views, proceed as follows:

1 Press **OK**, select **Organiser** > the view of your choice and press **OK**.

2 Once you entered the selected view, move **▲** or **▼** to display the previous or next day, week or month.

3 Press **OK** to display the list of corresponding events or to create a new one.

Time zone



Time zone

Although changing time zones is necessary when travelling a lot, be aware that it will impact all organiser reminders: the event alarms will be updated depending on the time displayed on the screen (see “Time and date” page 31).

Extras









This menu enables you to manage the [Call counters](#), [Euro converter](#), [Memo](#), [Alarm clock](#), [Calculator](#) and a [Brick game](#).

Brick game



Brick Game

 This menu can be subscription dependent. As such its icon and content may vary. This menu gives you access to a game which consist in breaking a complete set of bricks with a ball and a racket. When you have destroyed the last brick, you access the next level. Keys used are the following:

 and 	To move left or right
 and 	To throw the ball left or right
	To pause the game; pause time is limited to 2 mn after which the screen returns to idle mode and the game is lost.

Call counters



Call counters

This menu allows you to handle the cost and duration of your calls.

GSM counters



GSM counters

This menu gives you access to the following options described below.

 The GSM Call Counters do not include WAP connections. Most options mentioned below are subscription-dependent.



Accum. call timers

- **Accumulated call timer**
Select this option and press  to [Show](#) or [Reset](#) the time duration of [Outgoing](#) or [Incoming](#) calls.



- **Accumulated cost (subscription dependent)**

Allows you to display the accumulated cost and to set the counter to zero. It may be protected by PIN or PIN2 codes.



Show

Shows how much has been spent, having established the charge rate.



Reset

Allows you to reset the current **Accumulated cost** to 0; requires your PIN2 code.



Show balance

Allows you to check the remaining credit (compared with previously set limit).



Cancel cost limit

Allows you to cancel the cost limit. It may be protected by PIN or PIN2 codes (depending on your subscription).



Cost limit

Allows you to enter the cost limit used in the **Show balance** menu.



Charge rate

Allows you to set or change the rate per unit. First enter the currency used (three characters maximum) then enter the cost per unit.



Info at call end

- **Info at call end (subscription dependent)**

Allows you to activate or deactivate the systematic display of the length and/or cost of each call when hanging up.



Last call info

- **Last call information (subscription dependent)**

This menu allows you to display the duration and/or cost of your last call.

GPRS counters



GPRS counters

This menu allows you to select either one of the following options:



This feature is subscription and network dependent.



Mobile session

- **Last mobile session**

This option will display the last connection session or transfer volume of your mobile phone (e.g., after a WAP connection over GPRS).



PC session

- **Last PC session**

This option will display the last connection session or transfer volume of your PC transmission (e.g., when sending files from a PC with a data connect kit).

-  The call and counters managed by your mobile phone might differ from the ones used by your operator. You should therefore consider the call counters displayed on the screen as informative items, but NOT as the actual charge rate basis.

Euro



-> Euro



Euro ->

The **-> Euro** menu enables you to convert a sum into Euros by entering the amount and pressing **OK**.

The **<- Euro** menu enables you to convert a sum from Euros by entering the amount and pressing **OK**.

-  The currency used for the conversion is determined by the country where you have subscribed. The Euro converter is available upon subscription and only in countries using the Euro.

Memory status



This menu allows you to display the percentage of memory available in your phone. Several features share the mobile capacity (images, own melodies, etc.). Press **OK** to check the memory status showing the memory used out of the total amount available, and press **OK** again to access the list.

-  If "List full" appears when saving a new item or to free memory space, you must delete an item (e.g., a name or an event) to be able to create or add a new one.

Calculator



This menu provides the following functions:

- | | |
|----------------|---------------------------------------|
| Addition | By pressing the + key. |
| Subtraction | By pressing the - key twice. |
| Multiplication | By pressing the * key 3 times. |
| Division | By pressing the / key 4 times. |
| Equals | By pressing the = key. |

Enter the figures using the keypad. Calculator accuracy is to 2 decimal places and is rounded up to the higher decimal figure. Press **C** to correct the numbers. Press and hold **.** to get the dot. Press and hold **C** twice to return to idle mode.

Alarm clock



This menu allows you to set the alarm clock. Select **Extras, Alarm clock**, then press ◀ or ▶ to activate it. Enter the time, then press **OK** and select:

- **Once** activates the alarm at a set hour on a set day,
- **Every day** activates the alarm at a set hour every day of the week,
- **On weekdays** activates the alarm at a set hour on weekdays only.

Then select one of the alarm alerts: the buzzer; a melody or a memo recording if stored and press **OK** to confirm your choice.

 *The alarm clock will ring even if you turned off your phone, but NOT if the Ringer volume is set to **Off** (see page 27). Press any key to stop the alarm ringing.*

Memo



This menu allows you to record a memo of 30 seconds maximum.

Select **Extras > Memo** and press **OK**. Select **Record** to record a new memo.

Follow the instructions on the screen and press **OK** once your memo is recorded. The corresponding icon appears on the screen in idle mode until you play it or delete it. You can then select **Delete**, **Playback** or **Play back with Handsfree**.

 *Memo and conversation recording both share this menu (see “Record a conversation” page 20). You can only record one memo or conversation at a time: if another one is recorded, it will replace the previous one.*

9 • E-mail

If not included in your phone subscription, you must subscribe to an e-mail account (over the phone or via Internet from a computer) and have received the settings information from your provider. In this case, all parameters are communicated to you by your provider and/or operator as described below and must be entered as given.

If included in your subscription, you simply have to enter the login, password and e-mail address of your e-mail account.

Introduction



Your mobile phone features an e-mail application allowing you to send and receive e-mails, like you would do from a PC (an attachment such as a jpeg image can also be included). E-mails can then be forwarded to someone else and attachments stored in your mobile phone.

This feature is subscription-dependent and specific to Internet Service Providers (ISP): your mobile phone readily supports them if they are included in your subscription. Contact your ISP for detailed information on availability and rates.

 Mailboxes 1 and 2 feature the same settings and options. Configuring them differently will allow you to have two different e-mail accesses/addresses from your mobile phone.

To enter text and numbers, including specific signs such as @ or %, refer to the characters table described page 6.

E-Mail

Mailbox 1 / Mailbox 2

Settings

Network access

GSM settings**

GPRS settings*

Bearer

E-mail server**

Advanced**

Open Mailbox

Previous

[Header selected in the list]

Get mail / Details /

Reply / Forward to /

Add to names / Delete

Next

Send mail

Validate list / Add addressee



* Operator settings

** Internet service provider settings

As shown below, **two types of settings must be configured** before using the e-mail feature: the settings you get from your operator, needed to connect to the network (see “Network access”), and the ones you get from the e-mail service provider to connect to his server (see “E-mail server access”).



Telephone network GSM or GPRS connection

Network access
Info usually provided
by GSM operator



See “Bearer” page 62,
“GPRS settings” page 62
and “GSM settings”
page 63.



Internet network

E-mail access via GSM or GPRS

E-mail server
Info provided by
Service provider



See “E-mail server
access” page 63

Advanced
Info provided by
Service provider



See “Advanced”
page 64

Your phone might have been pre-configured. In this case, most parameters are already set and you don’t have to change them (except for [Login](#), [Password](#) and [E-mail address](#) which are up to you when creating an e-mail account).

In some cases, your operator might also be your e-mail service provider.

Settings

Network access



This menu allows you to configure your phone and to handle the connection to the network, whether GSM or GPRS, in order to *then* connect to the appropriate server that will let you send and receive e-mails.

All options described below are operator and/or subscription dependent.

- 1 Press **OK**, select **E-mail** then **Mailbox 1**, **Settings** and press **OK**.
- 2 Select **Network Access** and press **OK**.

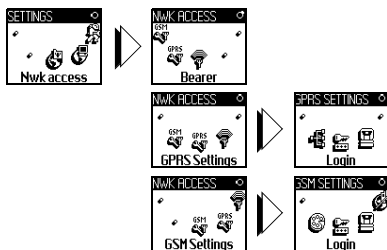

Bearer



Bearer

This menu allows you to select the type of network used when launching a connection. Press **◀** or **▶** to access one of the three choices, then **OK** to confirm:



GSM

-



GPRS

-



GPRS first

When selecting **GSM** or **GPRS**, your mobile will only use the GSM or the GPRS network for e-mail connections.

When selecting **GPRS first**, your mobile will first try to connect to the GPRS network, then to the GSM network if the GPRS network isn't available when launching an e-mail connection.

ⓘ Selecting this option requires you have configured both the GSM and GPRS settings.

GPRS settings



GPRS Settings

This menu allows you to enter or change the GPRS settings communicated to you by your operator, which are:



APN

-



Login

-



Password

ⓘ Error messages during connections are mainly due to incorrect parameters: you should contact your operator before first use, in order to have the appropriate GPRS parameters.

The **APN** (Access Point Name) must be entered as given to you by your operator; as well as **Login** and **Password**. This menu allows you to enter or change the GPRS settings communicated to you by your operator.

GSM settings



This menu allows you to enter or change the GSM settings communicated to you by your operator, which are:

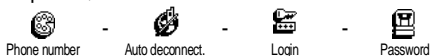

The **Phone Number** field allows you to enter the phone number provided by your ISP and needed to establish a connection. Press ◀ or ▶ to select:

- **ISDN Nber** to enter an ISDN ISP number, **OR**
- **Analogic Nber** to enter an analogic number, then press **OK**.

OK Contact your ISP to know what type of number you should select.

The **Auto disconnection** field allows you to select an inactivity time period after which the phone automatically disconnects (if a connection was in progress) from the network. Press ◀ or ▶ to select a value from 3 to 10mn and press **OK** to validate.

OK The lack of exchanges with the network (connecting, sending an e-mail, disconnecting) defines the inactivity time period leading to auto disconnection.

Login and **Password** were up to you when you subscribed to your account. Enter them also as defined.

E-mail server access



The menus described in this section feature settings needed to connect to the e-mail server of your Internet Service Provider (ISP) via your mobile phone. Most parameters are communicated to you from by service provider and must be entered as given.

1 Press **OK**, select **E-mail** then **Mailbox 1**, **Settings** and press **OK**.

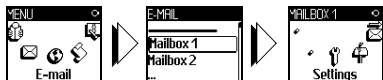

- 2 Select **E-Mail server** and press **OK**.

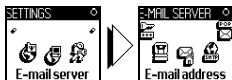

The fields to be completed are the following:



The **POP3 address** field allows you to enter the IP or DSN address of the POP3 server, which is used to **receive** e-mails.

The **SMTP address** field allows you to enter the IP or DSN address of the POP3 server, which is used to **send** e-mails.

ⓘ Network-dependent! For an e-mail connection via GPRS, if your phone operator is not your e-mail provider, contact your operator to get the correct address of his SMTP server and enter it in this field.

In some cases, **Login**, **Password** and **E-mail address** are up to you when you subscribe to your account. Enter them also as defined.

Advanced

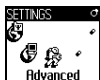

The menu described in this section feature advanced settings that may have been pre-configured, so that you shouldn't have to change any of them.

ⓘ *If the fields of these menus are empty, or if you encounter connection problems, contact your ISP.*

The fields of this menu are the following:

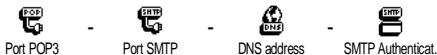

POP3 port field allows you to enter the POP3 port number, which is used to **receive** e-mails, and the **SMTP port** field allows you to enter the SMTP port number, which is used to **send** e-mails.

The **DNS address** field allows you to enter the DNS address of the external data network you want to connect to. The **SMTP authentication** item allows you to activate/deactivate the authentication process with the SMTP server.



ⓘ *In most European countries, this menu should be set to **Off**: your e-mails will NOT be sent if set to **On**. Contact your provider for complete information.*

Write and send e-mails



The **Send mail** menu allows you to send e-mails to one or several recipients at a time, including with an attachment such as a jpeg image. Once received, your messages can be forwarded and the attachments visualised with the appropriate software.

To one or several recipients

- 1 Press **OK** and select **E-mail**, then **Mailbox 1** or **Mailbox 2** depending on the one you wish to use. Select **Send mail** and press **OK**.
- 2 Move **▼** to select **Add addressee** and press **OK** to access the list.
 *If you select the phonebook "On SIM card", you will not be able to access any e-mail address, but an edit window will allow you to enter one. See "Phonebook" page 41 for information on phonebook selection.*
- 3 Select a name in the list and press **OK** to add it to your mailing list or press **CB** to cancel and go back to the previous sub-menu.
- 4 Back to the **Addressees** list, press **OK** to **Change** the e-mail address or to **Remove** it from the list, or select **Add addressee**, press **OK** to access the phonebook again and add new names to the mailing list.
- 5 Repeat steps 2 to 4 to add as many recipients as wanted.
- 6 Select **Validate list** and press **OK**. Then enter the subject of your e-mail (you can leave this field empty) and press **OK**.
- 7 In the next window, enter the text of your e-mail (you can also leave this field empty). Press **OK** when ready to send your e-mail.
 *To learn how to enter text, see "Text or number entry" page 4. If you exit the **Send e-mail** menu before sending your e-mail, its content is deleted without being stored.*
- 8 Select **Modify mail** and press **OK** if you want to change the content of your e-mail. This takes you back to step 2: follow the instructions from there to complete the list of recipients and send your e-mail.
- 9 Select **Send now** and press **OK** to send your e-mail. Your mobile phone connects to the Internet server, sends your e-mail to the names present in your mailing list, then disconnects.
 *You can cancel this operation by pressing and holding the **CB** key. Your mobile will then disconnect from the network, exit the e-mail menu and go back to idle.*



Disconnection also occurs each time you enter the **Settings** menu while a connection is in progress. In this case, your e-mail is lost.

Depending on the call settings you configured (see “Call waiting” page 38), you can receive calls during an e-mail connection. In this case, and if you accept the incoming call, your phone switches to the call screen context and the e-mail menu is closed; the phone goes back to idle when you hang up.

With an attachment



- 1 Repeat steps 1 to 7 described above. Select **Attach file** and press **OK**.
- 2 A list appears, showing the available JPEG files. Select the image you wish to send and press **OK**.
-  You can only attach one JPEG file at a time. If you exit the **Send e-mail** menu before sending your e-mail, its content (including attachment) is deleted without being stored.
- 3 Select **Modify mail** or **Send now** and press **OK** to confirm.

Receive and read e-mails

E-mails are received on a server, which you must connect to in order to retrieve your e-mails on your mobile phone (some operators send you a SMS when you receive a new e-mail). You must first download the headers from the server before retrieving the corresponding e-mails.

Connect to the server

Connection process





- 1 Press **OK** and select **E-mail**, then **Mailbox 1** or **Mailbox 2** depending on the one you wish to use. Select **Open mailbox** and press **OK**.
- 2 Your mobile phone automatically connects to the e-mail server and downloads the e-mails headers. If you didn't receive any e-mail, **List empty** is displayed on the screen. Otherwise, the e-mail headers are displayed in the form of a list.
- 3 The total number of mails received and pending on the server is displayed on the top of the screen, as well as the number of pages needed to display all headers.
- 4 Your mobile phone retrieves five e-mails headers at a time. If **Next** (respectively **Previous**) appears at the end (respectively beginning) of the

list, other e-mails headers are pending: select one of the available options and press **OK** to retrieve them.

-  An e-mail without any attachment may be automatically displayed in the details screen.

Headers information

Select a header, press **OK**, select **Details** and press **OK** again to see the address it was sent from, the date and time at which it was sent, its subject and the size of the attachment if any. The following status icons may appear in regards to each header:

- [No icon] The e-mail can be downloaded.
-  The e-mail size is too large, it cannot be downloaded.
-  The e-mail is marked to be deleted (see page 69).

Download e-mails







Simply select one of the retrieved e-mail headers and press **OK**. Then select **Get mail** and press **OK** to download the e-mail. Repeat this operation to download each e-mail corresponding to each selected header.

-  You can also press **OK** to access the e-mail header's carousel and select **Get mail** from the available options. If the e-mail is too big (over 7 KB), it is rejected and the download is cancelled.

Get and store attachments

If the e-mail you have received contains attachments (JPEG image, text file or another e-mail), they are characterised by a specific icon:

-  Contains the details of the e-mail header (date and time, sender's e-mail address, etc.), press **OK** to display these details.
-  The text of the e-mail itself can viewed as an attachment, press **OK** to read it. There isn't any advanced options in this case: it can be read, but not stored nor forwarded.
-  A text file (text only, ".txt" format) is attached to the e-mail, press **OK** to read it. There isn't any advanced options in this case either.
-  The application needed to manage this attachment isn't available in your phone, or the e-mail is too large to be uploaded.
- [Mail icon] Another e-mail is attached to the one you received (up to five e-mails can be attached one after the other). There isn't any

advanced options for an attached e-mail: it can be read, but not stored nor forwarded.



An image at the JPEG format is attached to this e-mail. Select the attached image in the list and press **OK** twice to store it in your mobile phone (you can rename it if you wish).



*You must have stored an image before being able to visualise it via the **Picture album** menu. See "Images album" page 24 for detailed information on this subject. If there isn't enough memory to store the new image, you must delete an item (name, event or image) to be able to store a new one.*

An image may not be accepted by your mobile phone if it is too large, or if it doesn't have the right file format. When receiving an image via e-mail, proceed as follows to obtain optimal results:

- The image received must have been saved in JPEG format, eventually featuring the extension JPG, JPE or JPEG.
- The size of the image file should not exceed 7 KB.
- The optimal size is 101 x 69 pixels (maximum height is 160 pixels, and maximum width 128 pixels), in 24 bits in order to be displayed correctly. We recommend you use a standard picture editing software to find the size of the image you want to send to your mobile phone.
- Use a filename of maximum 10 characters. You can then add an extension such as ".jpg".

Add an e-mail address to the phonebook



You must have selected the phonebook in your phone to be able to add an e-mail address; this menu item will NOT appear if you selected the SIM phonebook.



Add to names

You can add the sender's e-mail address to your phonebook, even when you haven't yet downloaded his e-mail (retrieving the header only is sufficient to access the e-mail address).

- 1 Select an e-mail header, then press **OK** to access the carousel options.
- 2 Select **Add to names** and press **OK**. Then select:
 - <new> to create a new name, enter first and last name then add the associated e-mail address, **or**
 - a name in the list and press **OK** to add the e-mail address to this name card. If it already contains an e-mail address, you will be prompted to press **OK** to replace it.

Delete e-mails



- 1 Select the e-mail to be deleted and press **OK** to access the options.
- 2 Select **Delete**, and press **OK** to confirm and mark the e-mail to be deleted. A small icon allows you to spot the header(s) of the list corresponding to the e-mail(s) to be deleted.
 *To unmark the e-mail to be deleted, select this option again.*
- 3 When you exit the **E-mail** menu, you will be asked to confirm deletion of the selected item(s) from the e-mail server. Press **OK** to confirm or **CB** to cancel (in this case, the marked e-mails remain in the list and aren't marked to be deleted anymore).

Reply to an e-mail



- 1 Select the header of the e-mail you want to reply to, press **OK** to access the options menu, then select **Reply** and press **OK**.
- 2 The address of the sender, which you can modify (see “To one or several recipients” page 65), is automatically added to the **Addressees** list. Select **Validate list** and press **OK**.
- 3 A new screen appears, that contains the subject of the received e-mail preceded with **Re:** standing for "Reply". Press **OK**.
- 4 Enter the text of your mail, then press **OK** to send it: select **Send now** and press **OK** to send your reply.

Forward an e-mail



- In order to forward an e-mail to another recipient, you must first have downloaded it (see “Download e-mails” page 67). From the **Forward to** option, proceed as described above in “Reply to an e-mail”.
-  *In both cases (reply to an e-mail or forward it), your phone will disconnect from the server when reaching the network inactivity time out set in the **Auto disconnection** menu (see “Bearer” page 62). It will reconnect to this server when sending the e-mail.*

10 • WAP services

Introduction



Most items of the **Operator Services** menu (e.g. Service numbers, Services +) are subscription-dependent and specific to operators: your mobile phone readily supports them if they are included in your subscription. Consequently, the menus shown opposite may or may not be available. The **WAP** option (independent from the two other options shown above), is described below in detail. Contact your network operator for detailed information on availability and rates.

 *The services provided may involve making a phone call or sending a SMS for which you may be charged. Contact your operator before initial use, in order to make sure your subscription supports the WAP feature and your phone has the appropriate WAP parameters. With some operators, WAP access parameters can be set remotely. Please check directly by your operator.*

Oper. Services

Service numbers

WAP

Advanced

Images / Status icons /

Download fun URL

Access settings

Show / Activate /

Change

Help

Launch

Favourites

Delete / GotTo /

Change

Last page

Alerts

Services +

WAP



Your mobile phone supports services based on the Wireless Application Protocol (WAP). The built-in WAP browser will allow you to access services supplied with your network, such as news, sports, weather, timetables, etc.

Launch



Your phone may have been pre-configured to directly access the services offered (if not, see “Favourites” page 71). The **Launch** menu allows you to access the online services provided with your operator. There are 2 ways to access these services:

- In idle mode, press and hold **@**, or
- In idle mode, press **OK**, select **Oper. Services**, **WAP**, **Launch** and press **OK**.

An animation shows the phone is connecting to the homepage. Once the browser is launched, you are connected to your operator's homepage. The following commands enable you to navigate through the WAP pages:

- Move ▲ or ▼ to navigate the online pages.
- Press **OK** to select an highlighted item.
- Press **@** to select the left or right option box displayed on the screen.
- Press **C&A** to return to the previous page.
- Press and hold **C&A** or **@** to end the online session.

Browse

During navigation, press ***#** to access a special menu with the following options (subscription dependent):

- **Reload** to reload the last card viewed.
- **Mark site** to add the previous deck to the user's bookmark list (network dependent).
- **About...** displays browser version and copyright information.
- **Advanced** displays a menu containing advanced commands:
 - **Show URL**: to display the URL of the previous card,
 - **Goto URL**: to fetch the content of the URL entered,
 - **Restart UP. browser**: to empty the contents of the cache memory and create a new session.
- **Exit**: to quit the WAP application and return to idle mode.
- **Bookmarks** to display the stored bookmarks.
- **Security** to display the security administration options (current certificates, authentication, encryption, etc.). Also available via a long press on **@**,
- long press on **@** to **→** requests the page bookmarked by **Mark site** (subscription dependent).

Favourites



Favourites

Allows you to store direct links to your favourite WAP pages.

- 1 Select **Favourites** and press **OK**, then select **<New>**, enter the name of the WAP page of your choice (e.g. "Philips") and press **OK**.
- 2 Then enter the URL address of the homepage (e.g. `http://wap.pcc.philips.com`) and press **OK** to store it.

Entering this menu again allows you to **Delete**, **Goto** or **Change** this Favourite.

Last page



Allows you to access the last pages browsed without reconnecting to online services.

Advanced



This menu allows you to customise the way the pages are displayed on your phone and to define the URL address that will allow you to download iMelodies, pictures and animations.

Images



To activate/deactivate the downloading of images attached to WAP pages. The **Off** setting speeds up the global downloading time of the pages browsed.

Status icons



To activate or deactivate the header display. Deactivating this function allows you to gain an extra line of text on your screen.

Download fun URL



To enter or change the URL of the Download fun server (depending on your subscription, this field may be locked, preventing re-programming).

 *Some pictures may have a specific file format, so that even though they are displayed on the screen during a Wap session, you won't be able to save them in your phone.*

Access settings



Several WAP profiles are available, which allow you to personalize different WAP accesses. If your phone was pre-configured, it shouldn't be necessary for you to change the connection access settings. Nevertheless, depending on your subscription, you may configure the parameters described further:

 *All options described below are operator and/or subscription dependent. With some operators, you may be sent a SMS which contains new WAP access parameters that will be stored automatically. Please contact your network operator for detailed information on this subject.*

The three access settings available in this menu are the following:



-



-



Each of these settings allows you to:



- Visualise all parameters of the selected WAP profile (Gateway IP Address, Homepage address, phone number, etc.), either GSM or GPRS,
- **Activate** the selected profile (which then becomes the default profile and is used for connection when pressing ) ,
- **Change** the parameters of the WAP profiles as described below.

 Some pre-configured profiles might be locked, preventing re-programming.

Change name



Change name

Allows you to enter or change the name of the selected WAP profile. Press , enter the name of your choice and press  to confirm.

GSM settings



GSM settings

Allows you to enter or change the GSM settings and gives you access to the following items:



Login

-



Password

-







Phone number

-





Inactivity time



Login and **Password** allow you to enter the login and password needed. In both cases, enter the information and press  to confirm.

Phone Number allows you to enter the phone number needed to establish a connection with your WAP Service Provider (ISP). Select **Phone numbers** and press , then press  or  to select:

- **ISDN No.** to enter an ISDN ISP number, **OR**
- **Analogic No.** to enter an analogic number, then press .

Enter the "+" sign followed by the number provided by your operator and press .

 *Contact your operator to know what type of number you should select.*

Inactivity time allows you to enter an inactivity time period after which the phone automatically ends the WAP session (if a connection was in progress) and returns to idle screen. Select **Inactivity time** and press , then enter a value (in second) of over 30 s. and press .

GPRS settings



GPRS settings

Allows you to enter or change the GPRS settings and gives you access to the following items:



Login

-



Password

-



APN

-



Inactivity time

Login, **Password** and **Inactivity time** are the same fields as for GSM settings. Please refer to the previous section for information.

APN allows you to enter the address of the external data network you want to connect to, a text string or IP address (e.g., wap.operatorname.fr) used to establish the connection with your WAP Service Provider (ISP). Select **APN** and press **OK**, then enter the appropriate address and press **OK**.

 *Error messages during WAP connections are mainly due to incorrect parameters: you should contact your operator before first use, in order to have the appropriate WAP and GPRS parameters. With some operators, WAP access parameters can be set remotely. Please check directly by your operator.*

Gateway



Gateway

Allows you to enter or change the IP address and port number (subscription dependent) for the gateway: select Gateway and press **OK**, then enter the IP Address and press **OK**.

Homepage



Homepage

Allows you to enter the WAP address of the homepage, the first page displayed when accessing the WAP services. Select **Homepage** and press **OK**. Then enter the URL address of the homepage (e.g. www.philips.com) and press **OK**.

 *This feature is network-dependent: if the operator's gateway gives an URL, it will have priority on the Homepage URL you defined.*

Bearer



Bearer

Allows you to select the type of network used when launching a WAP session and gives you access to the following items:



GSM

-



GPRS

-



GPRS first

When selecting **GSM** or **GPRS**, your mobile will only use the GSM or GPRS network for WAP connections. When selecting **GPRS first**, it will first try to connect to the GPRS network, then to the GSM network if the GPRS one isn't available when launching WAP.

11 • Other operator services

Introduction



Most items of the Operator Services menu (e.g. Service numbers, Services +) are subscription-dependent and specific to operators: your mobile phone readily supports them if they are included in your subscription. Consequently, the menus shown opposite may or may not be available. Contact your network operator for detailed information on availability and rates.

 *The services provided may involve making a phone call or sending a SMS for which you may be charged.*

Oper. Services

Service numbers

WAP

Access Settings

Help

Launch





Settings

Services +







GSM strings

The phone supports standard GSM strings that can be sent from the keypad to the network and used to activate services provided by the network.





- Example n° 1

Press    , then , to activate the Call Waiting service.





- Example n° 2

Press     , then , to know if the mobile identification has been sent.

- Example n° 3

Press    , then , to activate the feature call forward if no reply.





- Example n° 4

Press    , then , to activate the feature call forward if unreachable.

 *Contact your network operator for detailed information on GSM strings.*

Query a voice server, voice mailbox, messaging service, etc. (DTMF tones)

Some phone services (such as phone answering machines and pagers) require your phone to transmit DTMF tones (Dual Tone MultiFrequency), also known as “touch tones”. These are used to communicate passwords, callback numbers, caller choices, and so on.

You can send DTMF tones at any time during a call by pressing any of the keys  to ,  and . You can also attach a DTMF sequence to a phone number before dialling it (or storing it in the [Phonebook](#)). The phone number and the DTMF part must be separated by a wait character.

Pause and wait characters

To obtain a pause or wait character, press and hold . The display shows **w** for a wait and **p** for a pause. The phone always interprets the first pause character as a wait character. When you dial a number containing a wait character, your phone dials the first part (the phone number) and then waits for the call to be connected before sending the rest of the digits as DTMF tones. Any subsequent pause character is an ordinary pause that generates a delay of 2.5 seconds.





Access your answering machine (example)

To hear all messages (e.g. code 3) on your answering machine (password 8421) at phone number 12345678, you could call: [12345678w8421p3](#).

The phone dials 12345678 and waits for the call to be connected. When connected, the phone transmits 8421 (the password), pauses 2.5 seconds, and then sends the last digit. If you find that 2.5 seconds is not long enough for your needs, you can enter several pause characters one after the other to increase the pause time.



Make a second call

You can make a second call during an active call or during a call on hold. You can switch between the two calls (the cost displayed on the screen depends on local charge rate).

- 1 While already on the phone, dial a number then press . The first call is put on hold and the number is displayed at the bottom of the screen. The second number is then dialled.
- 2 To toggle between the two calls, press  then select **Switch calls**. Each time that you toggle from one call to another, the active call is placed on hold and the call which was on hold is activated.
- 3 To hang up the active line, press . The active line is hung up and the call on hold remains as such.
- 4 To end the call on hold, use **Switch calls** to reach it, then press .

 **Notes:**

The second number can be dialled either from the keypad or from:

- the phonebook, by pressing , then selecting the name to be called,
- the Call list, by pressing , then selecting the number to be called.



Answer a second call

You are able to receive another call when already in communication (if this feature is available with your subscription). When you receive a second call the phone emits an alert beep and the screen displays **Call waiting**.



 **Warning!** To receive a second call, you must have:

- subscribed to this feature,
- deactivated the Call forward option for voice calls (see page 35),
- activated the Call waiting option (see page 37).

If you receive a second call, press , then you can:

- accept the second call: the first one is put on hold, the second one is active. If you want to toggle between the two calls, press  then select **Switch calls**. Each time you toggle from one call to another, the active call is put on hold and the call which was on hold is then activated. To introduce the new caller into a conference press  and select **Conference**.
- reject the second call
- end the active call, then your incoming call is ringing.

 **Notes:**

- If you also wish to answer the incoming call, press ; to reject it, press .



- If you have activated call forwarding 'If Busy' (see "Call forward" page 35), you will never receive second calls since they are always forwarded when the line is busy.

Answer a third call (Subscription dependent)

While in communication and one call being on hold, you may receive a third call. The phone emits an alert beep. You can either end one of the calls before being able to answer the third one or introduce the calling party into a conference (see below). This service is limited to two current communications (one active and one on hold).

Conference Call (Subscription dependent)



Conference

You can activate the conference call by making consecutive outgoing calls, or create it from a multiparty call context. You may have up to five members at the same time and end the conference with . At this point all calls are disconnected.

In order to make consecutive outgoing calls, first initiate a normal call with the first number of the conference. When the first member is on line, initiate a second call as described in "Make a second call" above. When the second call is engaged, press and select **Conference**. Repeat the above process until five members are connected.

If there is an incoming call during the conference call, and if there is less than five members, you can accept this new call by pressing . Press again and then select **Conference** to add this member to the conference call. If there is an incoming call during a conference with five members already connected, you can answer this new incoming call, but not add it to the conference.

While a conference call is in progress, press to access the **Conf. members** options. Disconnect a member of the conference by selecting **Remove party** and pressing to confirm, or select **Private call** to have a private call with this member only (other members are put on hold).





Explicit Call Transfer (Subscription dependent)

You can connect an active call and a call on hold. You are disconnected when the transfer is completed. During a call press , select **Transfer** and press .

This feature is different from the Call forward, which takes place before you pick up the call (see page 35).

In-call symbols

During calls, the following symbols can be displayed:

- | | | |
|--------------------------------------------------------------------------------------------------------------|-------------------------------------------------------------------------------------------------|-------------------------------------------------------------------------------------------------|
|  Mute |  Incoming call |  Call underway |
|  Active call placed on hold |  Outgoing call | |

Precautions

Radio waves

- Your phone transmits/receives radio waves in the GSM frequency (900 / 1800MHz).
- The GSM network controls transmission power (0.01 to 2 watts).
- Your phone complies with all relevant safety standards.
- The CE mark on your phone shows compliancy with European electromagnetic compatibility (Ref. 89/336/EEC) and low voltage directives (Ref. 73/23/EEC).

Your cellular mobile phone is your **responsibility**. To avoid damage to yourself, to others or to the phone itself, read and follow all the safety instructions and make them known to anyone borrowing your phone. Furthermore to prevent unauthorised use of your phone:



- Keep your phone in a safe place and keep it out of small children's reach.
- Avoid writing down your PIN code. Try to remember it instead.
- Switch off the phone and remove the battery if you are going to leave it unused for a long time.
- Use the **Security** menu to change the PIN code after purchasing the phone and to activate call restriction options.



The design of your phone complies with all applicable laws and regulations. However your phone may cause interference with other electronic devices. Consequently you should follow all **local recommendations and regulations** when using your cellular phone both at home and when away. **Regulations on the use of cellular phones in vehicles and aircraft are particularly stringent.**



Your cellular mobile phone is a **low power radio transmitter and receiver**. When it is operating, it sends and receives radio waves. The radio waves carry your voice or data signal to a base station that is connected to the telephone network. The network controls the power at which the phone transmits. Public concern has been focused for some time on the possible health risks for users of cellular phones. The current research on radio wave technology, including the GSM technology, has been reviewed and safety standards have been drawn up to ensure protection from exposure to radio wave energy. Your cellular telephone **complies with all applicable safety standards** and the Radio Equipment and Telecommunications Terminal Equipment Directive 1999/5/EC.

Inadequately protected or **sensitive electronic equipment** may be affected by radio energy. This interference can lead to accidents.

Always switch off your phone



- Before boarding an **aircraft** and or when packing the phone in your luggage.
- In **hospitals**, clinics, other health care centres and anywhere else where you may be in the close vicinity of **medical equipment**.
- If you are a user of a **pacemaker** or **hearing aid**, or expect to use your cellular phone in the immediate vicinity of someone who does, then take the precautionary steps described below.



- Consult your physician and pacemaker or hearing aid manufacturer to learn whether your particular device is susceptible to cellular phone interference.
- Carry and hold your cellular phone at safe distance from the implanted pacemaker device and electrode (20 cm is generally accepted as a "safe distance", however it is advisable to check with your physician and pacemaker manufacturer).

Always switch off your phone and do not remove the battery



- In areas with a potentially **explosive atmosphere** (e.g. petrol stations and also areas where the air contains dust particles, such as metal powders).
- In a vehicle transporting flammable products (even if the vehicle is parked) or a vehicle powered by liquefied petroleum gas (LPG), check first that the vehicle complies with the applicable safety rules.
- In areas where you are requested to turn off radio transmitting devices, such as quarries or other areas where blasting operations are in progress.



Check with the vehicle manufacturer that **electronic equipment** used in your vehicle will not be affected by radio energy.

In order to **improve the performance of your phone**, reduce radio energy emission, **reduce battery consumption and ensure safe operation adhere to the following guidelines:**



- For the optimal and satisfactory operation of the phone you are recommended to use the phone in the normal operating position (when not using in hands-free mode or with a hands-free accessory).
- Do not expose your phone to extreme temperatures.
- Treat the phone with care. Any misuse will void the International Guarantee.

- Do not immerse the phone in any liquid ; if your phone is damp, switch it off, remove the battery and let them dry for 24hrs before using them again.
- To clean the phone, wipe it with a soft cloth.
- Placing and receiving calls consumes the same amount of battery energy. However, the mobile consumes less energy in idle screen when kept in the same place. When in idle screen and while you are moving, your phone consumes energy to transmit updated location information to the network. Setting the backlight for a shorter period of time as well as avoiding unnecessary navigating in the menus will also help to save the battery's energy for longer phoning and stand-by performances.

Information displayed on the battery



- Your phone is powered by a rechargeable battery.
- Use specified charger only.
- Do not incinerate.
- Do not deform or open the battery.
- Do not allow metal objects (such as keys in your pocket) to short circuit the battery contacts.
- Avoid exposure to excessive heat (>60°C or 140°F), moisture or caustic environments.



You should only use Philips Authentic Accessories, as the use of any other accessories may damage your phone and will make all guarantees for your Philips phone null and void.

Make sure damaged parts are replaced immediately by a qualified technician and that they are replaced with genuine Philips replacement parts.

Do not use your phone while driving



It lowers concentration, which can be dangerous. Adhere to the following guidelines:

- Give your full attention to driving. Pull off the road and park before using the phone.
- Respect the local regulations in countries where you drive and use your GSM phone.
- If you want to use your phone in a vehicle, install the hands-free car kit which is designed for that purpose, still ensuring you give full attention to driving.

- Ensure that your phone and car kit do not block any airbags or other security devices fitted in your car.
- The use of an alarm system to operate a vehicle's light or horn to indicate incoming phone calls is prohibited on public roads in some countries. Check local regulations.

EN 60950 Norm





In case of hot weather or after a prolonged exposure to the sun (e.g., behind a window or a windscreen), the temperature of your phone's casing might increase, especially when featuring a metallic finish. Be very careful in this case when picking up your phone and also avoid using it with an ambient temperature over 40°C.

Environmental care





Remember to observe the local regulations regarding the disposal of your packaging materials, exhausted batteries and old phone and please promote their recycling.

Philips has marked the battery and packaging with standard symbols designed to promote the recycling and appropriate disposal of your eventual waste.

Battery: 	The crossed-out dustbin signifies that the battery should not be disposed of with general household waste.
Packaging: 	The mobius loop symbol signifies the labelled packaging material is recyclable.
	The green point symbol signifies that a financial contribution has been made to the associated national packaging recovery and recycling system (e.g. EcoEmballage in France).
	The chasing arrows symbol on the plastic tray and plastic bag indicate that the materials are recyclable and also identifies the plastic material.

Troubleshooting

PROBLEM	SOLUTION
The phone does not switch on	Remove and reinstall the battery (see page 8). Then charge the phone until the battery icon has stopped flashing. Finally, unplug from the charger and try to switch the mobile on.
The display shows BLOCKED when you switch on	Somebody tried to use your phone but didn't know the PIN code nor the unblocking code (PUK). Contact your service provider.
The Ψ and .ll symbols are not displayed	The network connection is lost. Either you are in a radio shadow (in a tunnel or between tall buildings) or you are outside the network coverage area. Try from another place or contact your network operator for assistance/information about the network.
The display doesn't respond (or responds slowly) to key pushes	The display responds more slowly at very low temperatures. This is normal and does not affect the operation of the phone. Take the phone to a warmer place and try again. In other cases please contact your phone supplier.
Your phone doesn't go to idle screen	Press and hold CB , or switch off the phone, check that the SIM card and the battery are installed correctly, and switch it on again.
Your phone doesn't display the phone numbers of incoming calls	This feature is network and subscription dependent. If the network doesn't send the caller's number, the phone will display Call I instead. Contact your operator for detailed information on this subject.
You can't send text messages	Some networks don't allow message exchanges with other networks. Contact your operator for detailed information on this subject.
You can't receive and/or store JPEG images	An image may not be accepted by your mobile phone if it is too large, or if it doesn't have the right file format. See page 66 for complete information on this subject.

<p>When charging the battery, the battery icon shows no bars and the outline is flashing</p>	<p>Only charge the battery in an environment where the temperature does not go below 0°C (32°F) or above 50°C (113°F). In other cases please contact your phone supplier.</p>
<p>You are not sure that you are receiving calls properly</p>	<p>To receive all calls, make sure that none of the features "Conditional call forward" or "unconditional call forward" is activated (see page 35). This network and subscription dependent feature may display one of the following icons:</p> <ul style="list-style-type: none">  call forward unconditional to number  call forward unconditional to voice mailbox
<p>When attempting to use a feature in the menu, the mobile displays not allowed</p>	<p>Some features are network dependent. They are only available, therefore, if the network or your subscription supports them. Contact your operator for detailed information on this subject.</p>
<p>The display shows SIM failure</p>	<p>Check that the SIM card has been inserted in the right position (see page 8). If the problem remains, your SIM card may be damaged. Contact your operator.</p>
<p>The display shows IMSI failure</p>	<p>This problem is related to your subscription. Contact your operator.</p>
<p>The display shows Insert your SIM card</p>	<p>Check that the SIM card has been inserted in the right position (see page 8). If the problem remains, your SIM card might be damaged. Contact your operator.</p>
<p>Your phone doesn't work well in your car</p>	<p>A car contains many metallic parts that absorb electromagnetic waves which can affect the phone's performances. A car kit is available to provide you with an external antenna and enables you to phone without handling the handset.</p> <p> <i>You should check with local authorities if you are allowed to phone while driving.</i></p>

Glossary

- Call barring** Enables you to restrict or bar certain or all types of calls to and from your mobile phone, i.e. outgoing calls, outgoing international calls, incoming calls. Barring is activated with a personal code. To use this service, it must be supported by your network and by your phone. You may also have to add this service to your subscription.
- Call forwarding** This feature allows you to program a number to which all incoming calls will be automatically rerouted.
- Call restriction** Enables you to restrict or bar certain or all types of calls to and from your mobile phone, i.e. outgoing calls, outgoing international calls, incoming calls. To use this service, it must be supported by your network and by your phone. You may also have to add this service to your subscription.
- Call transfer** Enables you to transfer a caller to another number. To use this service, it must be supported by your network and by your phone. You may also have to add this service to your subscription.
- Cell broadcast** Used now in GSM particularly, this paging service allows an operator to spread short information messages to all or dedicated subscriber surrounding a cell or a region.
- GPRS** **Generalised Packet Radio Service** - GSM network structure and methods development in terms of data connectivity with a high speed rate and dynamic allocation.
- GSM** **Global System for Mobile communications** - Digital wireless telecommunications standard widely used throughout the world and used by your phone. GSM 900 uses 900 MHz frequency band, whereas GSM 1800 uses 1800 MHz frequency band (see "Other operator services" page 75).
- Home Zone** A particular area within your home network. If this feature is provided by your home network, the home zone symbol is displayed indicated that you are currently within the home zone.
- Local network** The network where you are making a call. This may be your home network or another GSM network.

PIN	Personal Identification Number - An optional code used for all GSM-based phones to establish a personal authentication access to the phone menu. The PIN code is commonly given with your subscription and is the secret code of the SIM card.
PIN2	Another authorisation code which is used only for special services.
Public Names	Function that allows you to restrict dialling to selected numbers.
PUK	Personnal Unblocking Code - Used to unlock a blocked SIM card by entering a wrong PIN code 3 times. This is not commonly delivered with your subscription and several operators may apply a severe cost on this type of service.
PUK2	Used to unlock a blocked SIM card by entering a wrong PIN2 code 3 times.
Roaming	Traveling outside a wireless carrier's or subscriber's local or home coverage area. There is usually an additional charge for roaming.
URL	Uniform Resource Locator - URLs are the Internet equivalent of addresses. Like other types of addresses, they move from the general to the specific (from zip code to recipient, so to speak), e.g., http://www.pcc.philips.com/mobilephones/index.html http:// (protocol) /www.pcc.philips.com (server address or domain) /mobilephones/ (directory in which the file index.html resides).
WAP	Wireless Application Protocol - Organised and regulated by the WAP forum, WAP gives the opportunity to GSM network operator to run specific applications on a wireless network in using the Internet technology adapted to wireless phones.

Philips authentic accessories

When performance counts... Philips Authentic Accessories are designed to maximise the performance of your Philips mobile phone.

CHARGERS

Cigarette Lighter Adapter 12-24 V

- Charges the battery while you use your phone.
- Plugs into virtually any vehicle power outlet.

CKLR 12/P - 9911 240 34118



Fast Travel Charger 90-240 V

- Charges your battery in any AC outlet.
- Small enough to carry in a briefcase or handbag.
- Charging time between 75 and 120 minutes, depending on battery type and use.

ACSR 12/P - 9911 240 30042



Taiwan/USA: ACTR 12/P - 9911 240 30043

United Kingdom: ACUB 12/P - 9911 240 30044

Australia: ACAR 12/P - 9911 240 30045

China: ACCR 12/P - 9911 240 30054

HANDS-FREE KITS

Compact car kit

- Designed to operate your Philips mobile phone hands-free, using the built-in speakerphone unit and the mobile's microphone.
- Simply plug the kit into the vehicle auxiliary outlet.
- Easy to use, this compact hands-free solution offers a high audio quality while also charging your mobile.

CKSK 20/P - 9911 240 34306



Deluxe car kit

- External antenna connection for optimum reception and transmission quality.
- No separate loudspeaker necessary as the call connects directly to your audio system.
- Automatic radio mute function on incoming call.
- Full package including cradle.

CKFX 62/P - 9911 240 34435



Cradle with RF connector

- This cradle simplifies and secures the use of your phone in a car. The antenna connection enhances the reception quality.

Deluxe and extra-deluxe hands-free headsets

- In-line answer button offers you a simplified alternative to searching for the phone keypad: you answer an incoming call just by pressing the button. In idle mode, a long press activates the voice dial.
- Xtra Deluxe headset is a painted version featuring high quality metallic finish.

 *In certain countries, telephoning while driving is prohibited. For safe and trouble free installation, we recommend that specialized technicians install hands-free car kits.*

CKFR 62/P - 9911 240 34508

Deluxe headset

HSLD 15/P - 9911 241 30024

Xtra Deluxe headset

HSUX 38/P - 9911 241 31006



USB DATA CONNECT

- Easy data connection to your Philips mobile phone: no need for a PCMCIA card as the modem is built in your handset. Just connect your phone into your laptop via the data cable and you can then send faxes and SMS messages, access data communication facilities on mobile networks and connect to the Internet.

 *The USB data connect kit isn't compatible with Apple® Macintosh® computers. It is only supported by Windows® 98, 2000 and XP.*

DCCX 38/P - 9911 241 39224

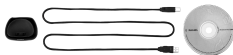

To maximise the performance of your Philips phone and not to void the warranty, always purchase Philips Authentic Accessories that are specially designed for use with your phone. Philips Consumer Communications cannot be held liable for any damage due to use with non authorised accessories. Ask for Philips Authentic Accessories where you purchased your Philips Phone.

Declaration of conformity

We, **Philips France**
Mobile Telephony Business Creation Team
of **Route d'Angers**
72081 Le Mans cedex 9
FRANCE

declare under our sole responsibility that the product
CT 3329
Cellular Mobile Radio GSM 900/GSM 1800
TAC: 350054

to which this declaration relates, is in conformity with the following Standards:
EN 60950, EN 50360 and EN 301 489-07
EN 301 511 v7.0.1

We hereby declare that all essential radio test suites have been carried out and that the above named product is in conformity to all the essential requirements of Directive 1999/5/EC.

The conformity assessment procedure referred to in Article 10(5) and detailed in Annex V of Directive 1999/5/EC has been followed related to articles 3.1 and 3.2 with the involvement of the following Notified Body:

BABT, Claremont House, 34 Molesey Road, Walton-on-Thames, KT12 4RQ, UK

Identification mark: **0168**

The technical documentation relevant to the above equipment will be held at:
Philips France, Mobile Telephony Business Creation Team
Route d'Angers
72081 Le Mans cedex 9
FRANCE

Le Mans, July 08, 2002

Jean-Omer Kifouani
Quality Manager